



## COLD AIR INTAKE INSTALLATION INSTRUCTIONS

PART NUMBER D760-0048(-A)

APPLICATION:	2017-19	F22 230i & xDrive
	2017-19	F23 230i & xDrive Convertible
	2017-19	F30 330i & xDrive
	2017-19	F31 330i xDrive Wagon
	2017-19	F34 330i xDrive Gran Turismo
	2017-19	F32 430i & xDrive
	2017-19	F33 430i & xDrive Convertible
	2017-19	F36 430i & xDrive Gran Coupe

Congratulations for being selective enough to use a Dinan Cold Air Intake Kit. We have spent many hours developing this kit to assure that you will receive maximum performance and durability with minimum difficulty in installation. Please take the time to read these instructions and call us if you have any difficulties during the installation.

Please take the time to read these instructions thoroughly before proceeding. When performing the installation, read the entire numbered instruction before working on the car. If you feel that you do not have the requisite skill, please arrange for a qualified repair facility to perform the installation.

If you have any difficulties during the installation, or if these instructions are not clear to you, please call Dinan's Technical Support Staff at (800) 341-5480.

Note: If the car has been driven recently or has been sitting out in the sun, it's best to let the engine bay cool down for approximately 10 minutes to avoid possible burns while installing the Dinan Cold Air Intake.

---

### PARTS LIST

Qty	Part #	Description
1	D762-0213-G(-A)	Airbox Lid
1	D762-0214	Air Flow Meter
1	D762-0218-G	Intake Tube
1	D340-0433	Silicone Hose; AFM
1	D340-0432	Silicone Hose; Turbo Inlet
1	D401-0025	Air Filter
1	D763-0094	Hardware Kit

---

## INSTALLATION:

1. Remove the plastic panel by pulling up on sides and sliding back to detach from front grommet mount.

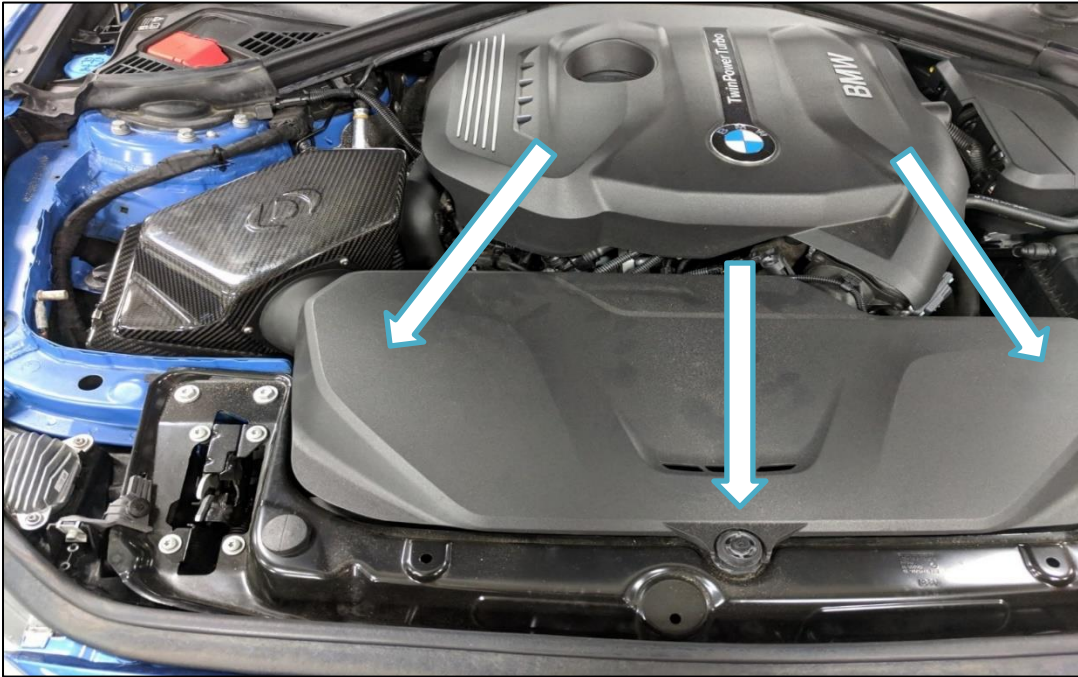

2. Unclip the air mass meter sensor harness from the sensor. Push down and back on the small grey tab, the clip should release with an audible “click”. Detach the connector from the sensor.



3. Release the four clips holding the airbox lid in place.

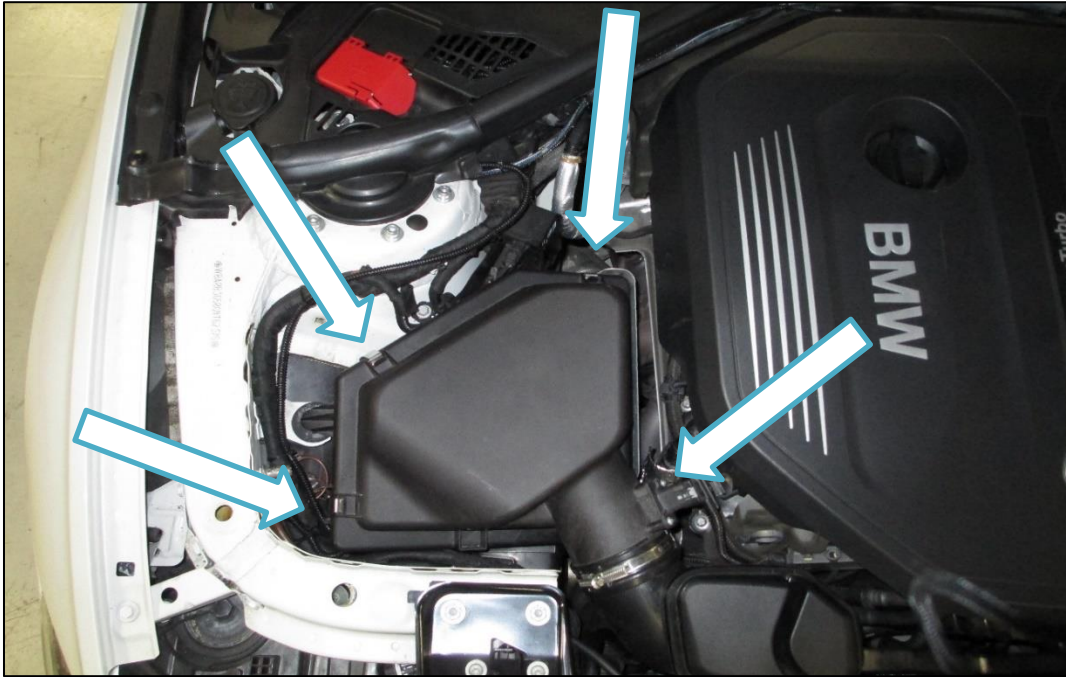

4. Follow the outlet of the airbox, down to the hose clamp near the turbocharger inlet. Loosen this hose clamp.

Note: If accessing this clamp is difficult, and additional clearance is needed, you may release the hose clamp by the air flow sensor and remove the upper airbox lid. If further clearance is needed, you may remove the lower air box by tugging upwards.

5. Remove the stock air intake assembly (see below image).



**WARNING – The turbocharger inlet is now exposed. Items which fall inside can cause severe damage to the turbo! Be sure to place a rag or towel in the inlet to protect from debris.**

6. Remove the original air filter from the lower airbox. This filter will not be reused.
7. Use a Torx tool to remove the two screws holding the sensor in place and remove the sensor. Do not drop or damage the sensor as it is very fragile. Set sensor aside. It will be reinstalled later.

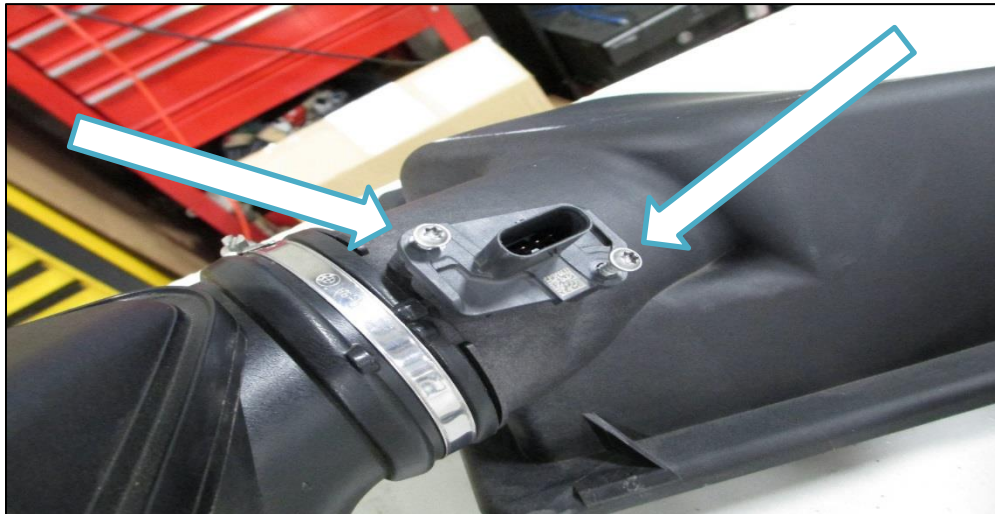

8. The spring clips which held the stock airbox lid will not work with the Dinan intake. Locate the new clips included with the hardware kit. The BMW clips are larger and wider, than the Dinan clips.

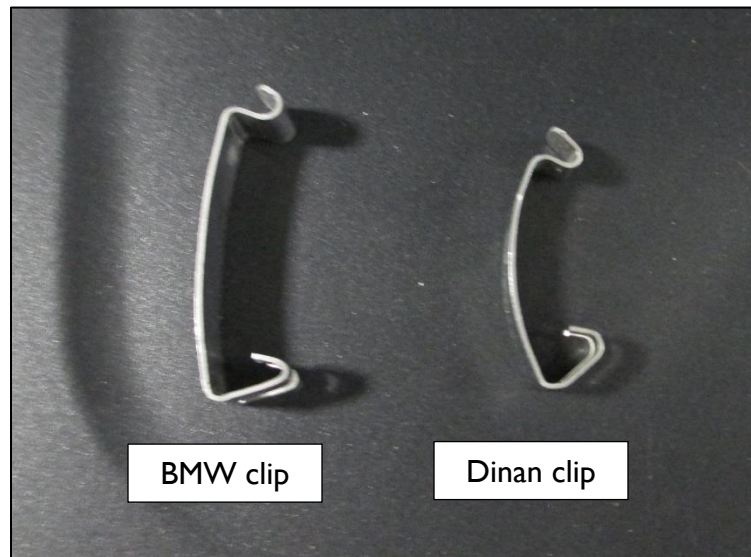

9. Remove the stock spring clips from the lower airbox. Simply bring the clip towards the airbox and push straight down as illustrated below.



10. Install all the Dinan spring clips into the lower airbox. If needed, remove the lower airbox to install the clips as pictured below. Seat as shown below. Push bottom of clip over lip until snaps into place. Press down to fully seat the spring against the box.

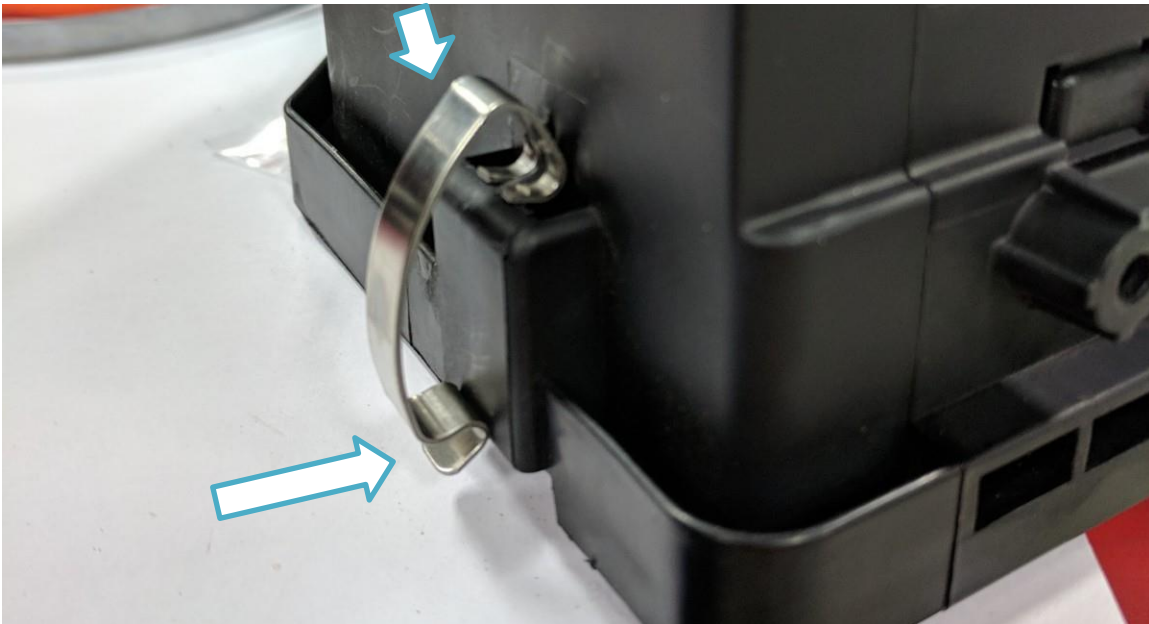

11. Clean out the track around the outside of the stock lower air box. Insert the adhesive gasket strip into the track after cleaning. Peel off the adhesive backing, install, and trim as needed to fit.



12. Referring to the figure below, attach the Dinan air mass meter to the carbon airbox lid using the 5mm bolts, round & rectangular washers, and nuts as shown. The air mass meter only fits one way.

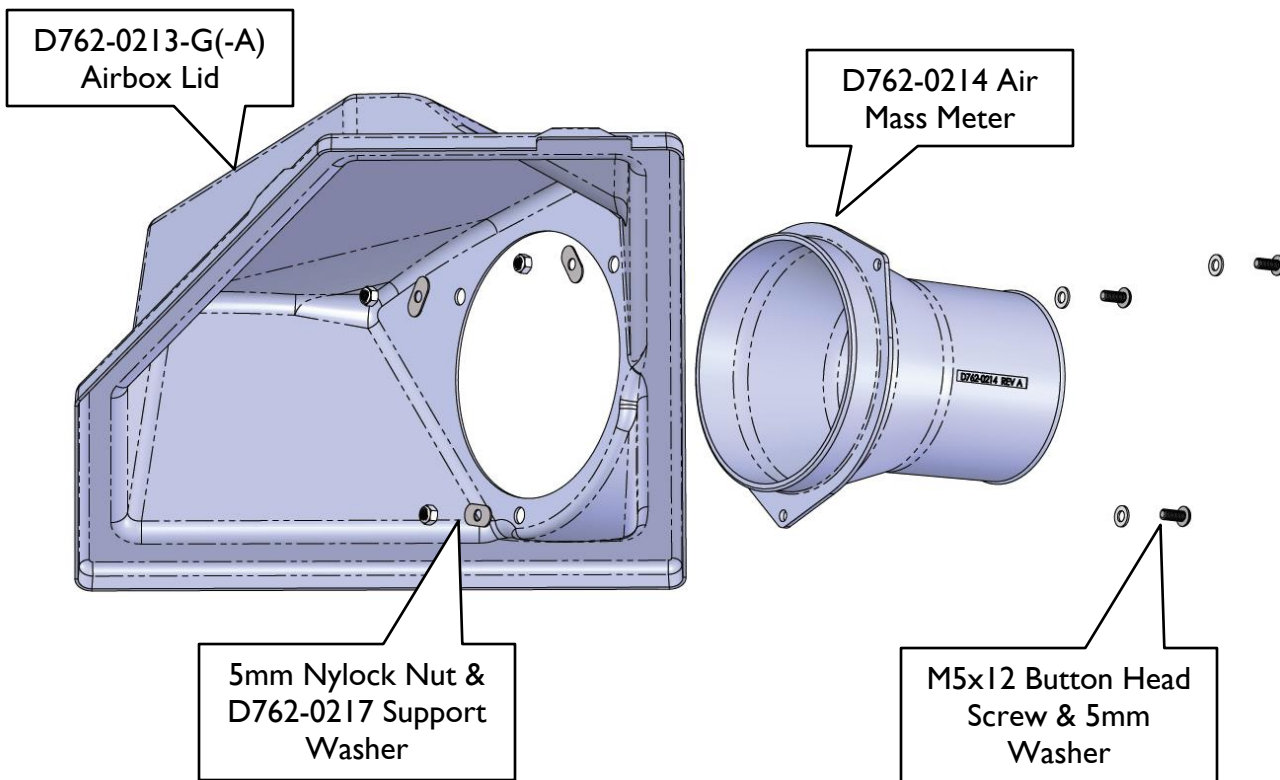

13. Attach and tighten the Dinan air filter to the air mass meter using the large #80Z hose clamp.



14. Attach the Dinan intake tube and silicone hoses using the included hose clamps as shown below. Leave the hose clamps slightly loose for now, so the intake tube can be adjusted into position later.

**WARNING: Remove the rag from the turbo inlet opening prior to the next step.**

15. Install the Dinan intake into the vehicle. Seat the Airbox and attach the intake tube over the turbo inlet. Adjust until all parts seem to sit naturally.



16. Secure the airbox lid with the 4 spring clips.

17. Tighten all hose clamps.

18. Install the stock sensor into the Dinan air mass meter with the stock screws.

19. Reconnect air mass meter wiring and secure the grey lock.

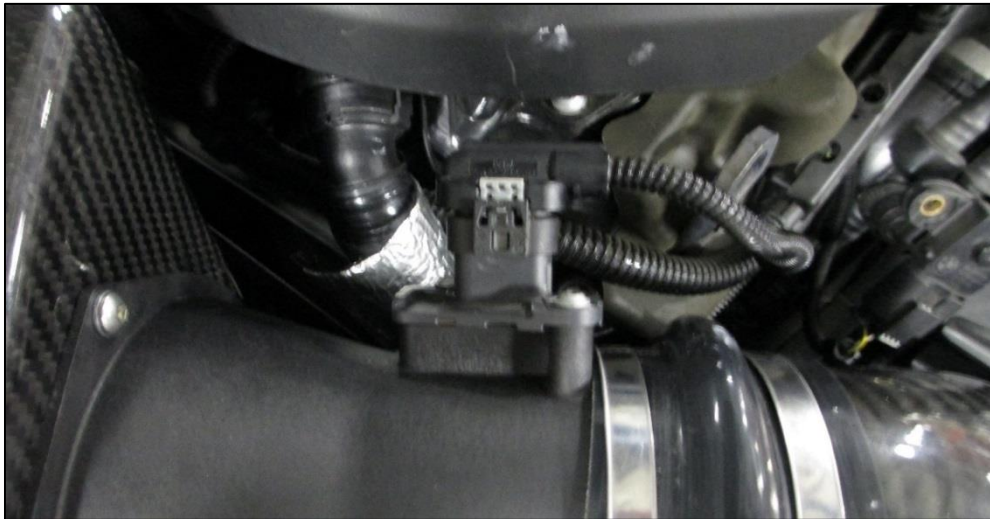

20. The face plate panel now must be reattached using provided pieces. First, remove one side of the adhesive back foam and attach to the provided mounting post.





21. Snap the ball joint mount into the mounting hole of the plate that will sit over the airflow meter tube. This is to replace the mount that was removed with the stock airbox.



22. CLEAN SURFACE OF AIRFLOW METER TO ENSURE PROPER ADHESION.

23. Prior to removing the adhesive backing, place the front cover back onto the car and notice how the mount will need to sit on the airflow meter. Adjust accordingly to ensure maximum surface area is in contact between the two surfaces. Remove the adhesive backing and set the mount in place on the air flow meter. Again, making sure that the entire adhesive pad is in contact, press down firmly to ensure proper adhesion.



24. The intake installation is now complete.



ENJOY