



## **Free Flow Exhaust Installation Instructions**

**PART NUMBER**  
**D660-0054**  
**D660-0054-BLK**

**APPLICATION:** 2015-18 X5 M (F85)  
2015-18 X6 M (F86)

---

Thank you for purchasing a Dinan High Performance Muffler! Some mechanical skill is required to install this muffler. If you are not familiar with this procedure, we strongly recommend that you arrange for a qualified BMW repair facility to perform this installation.

### **INSTALLATION:**

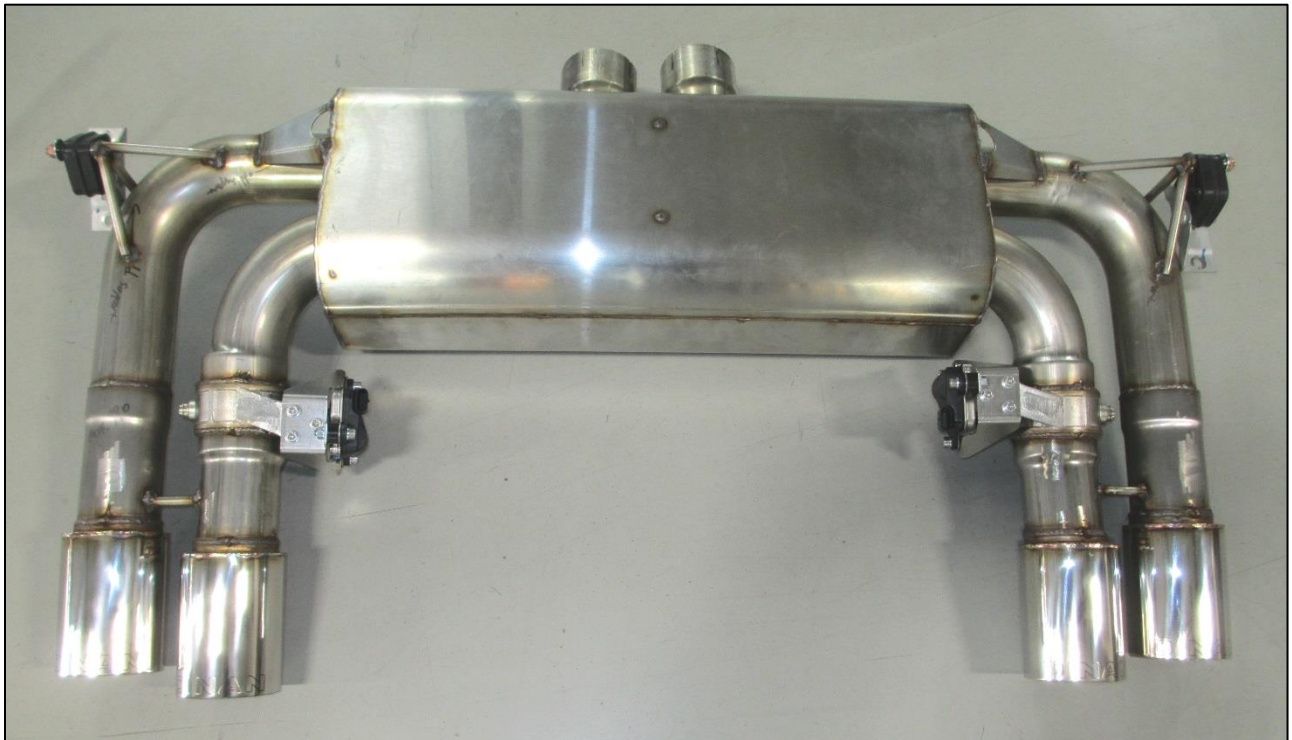

1. Disconnect both valve actuators.

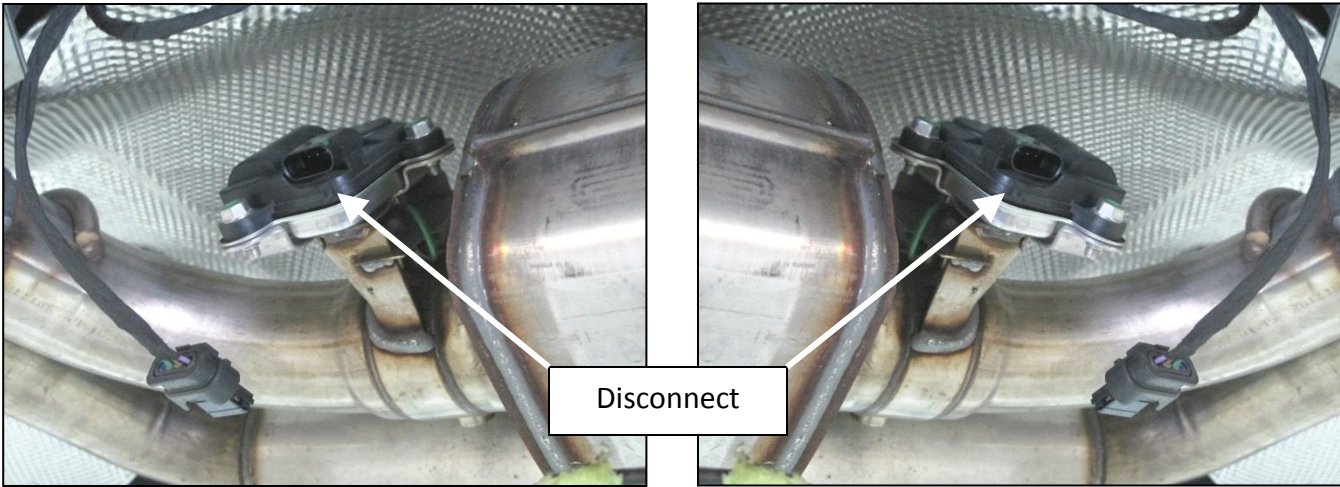

2. Support the muffler securely with a jack or stand then cut the stock muffler at the weld as shown in **FIGURES 1, 2 AND 3**.

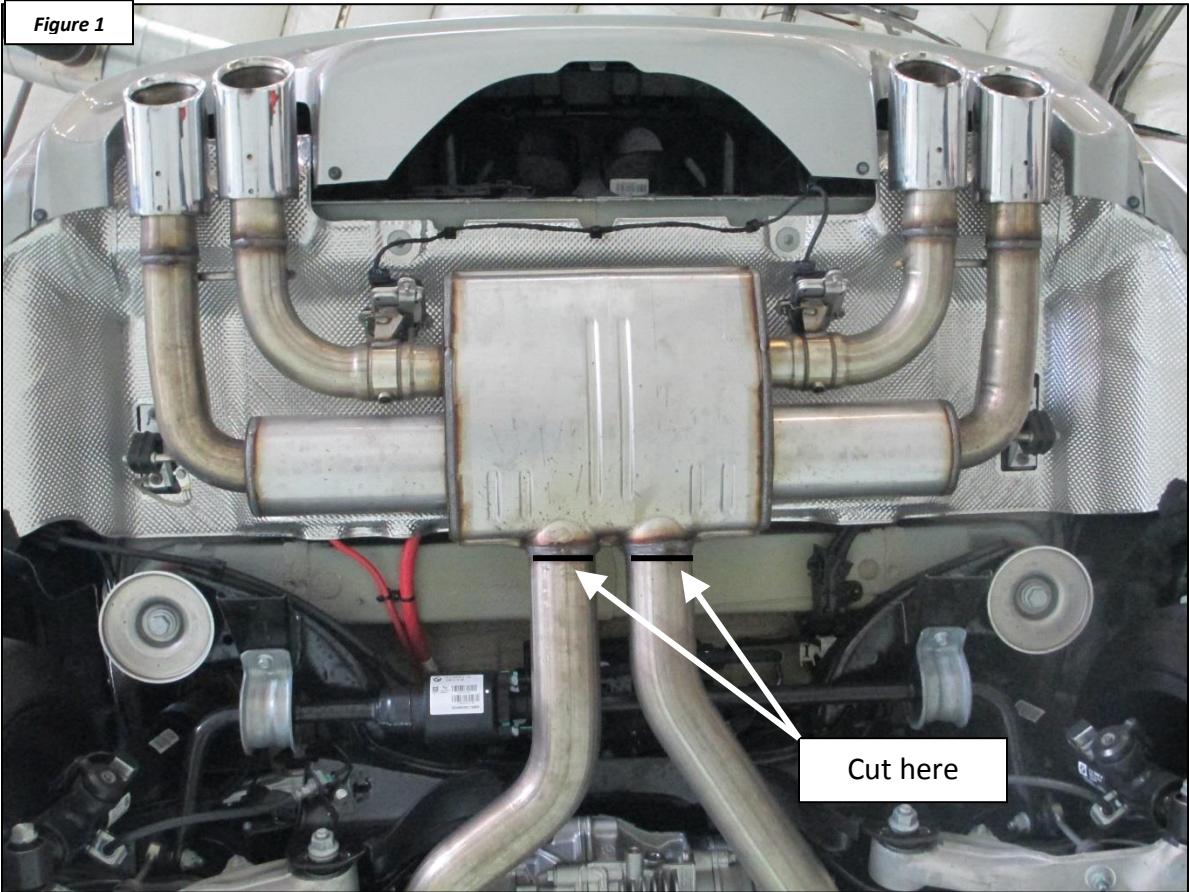

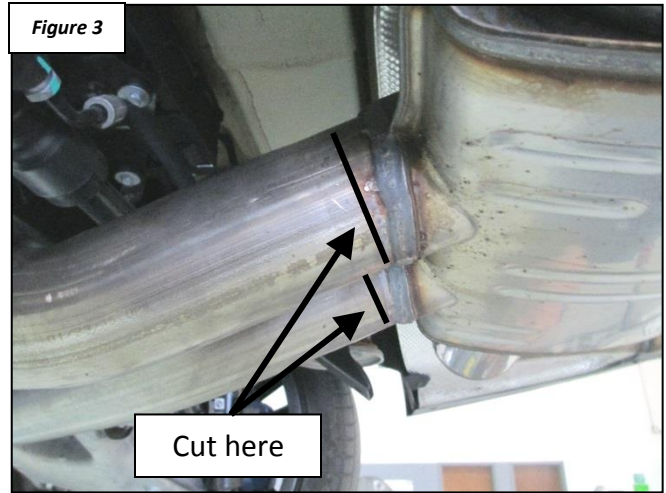
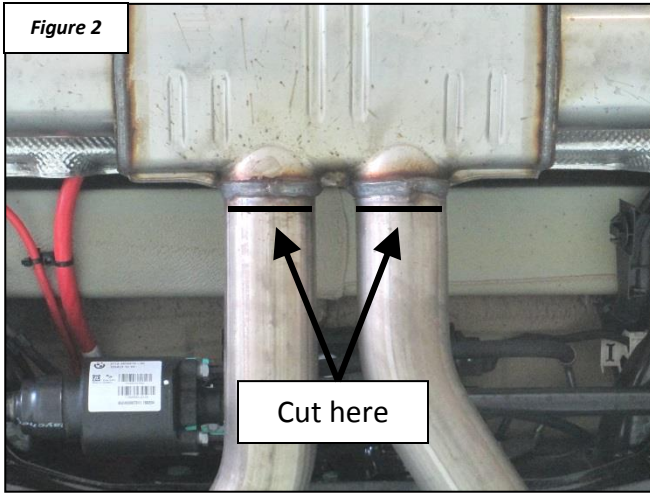

3. With the stock muffler fully secured and supported on a jack or stand, remove the hanger nuts as shown (SAVE THESE NUTS FOR INSTALLATION OF DINAN MUFFLER!). Then remove stock muffler. Be sure exhaust valve actuators are disconnected before finally removing the muffler.



4. Remove (2) hangers, (4) hanger mounting nuts, (2) valve actuators, (2) valve actuator plates, (2) valve actuator springs, (1) ground strap. **SAVE THESE PARTS FOR INSTALLATION OF THE DINAN MUFFLER!**

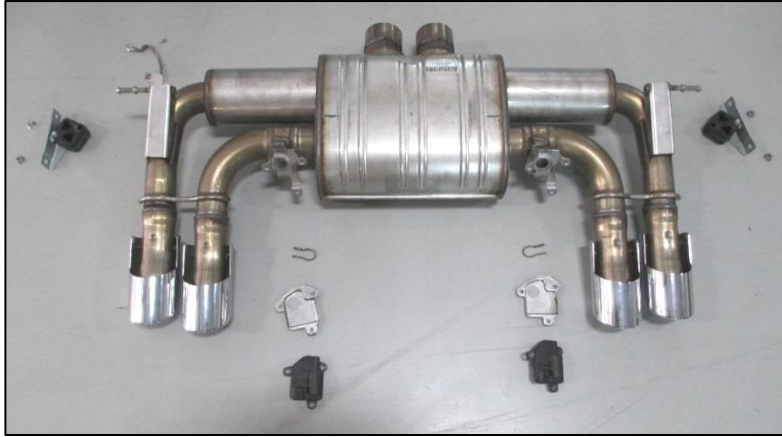

5. There are two types of DINAN exhaust valves. Examine the following diagrams to determine which type is on your DINAN exhaust. Using the hardware provided, install the valve actuator mounting brackets, as shown in the appropriate diagrams.

Use picture below for correct orientation of spring. While holding the spring in the slot on the valve, place the actuator (with actuator plate) onto spring. Mount the actuator to the mounting bracket using the provided hardware. Before you fully tighten bolts make sure shafts are aligned (see photo). If the stock actuator shaft slot is in a different rotation than pictured below, simply turn the valve shaft slot on the muffler to line them up. Make sure all hardware is tight. **THE SPRING MUST BE SECURELY SEATED IN BOTH THE SLOT IN THE VALVE AND THE SLOT IN THE ACTUATOR!!!**

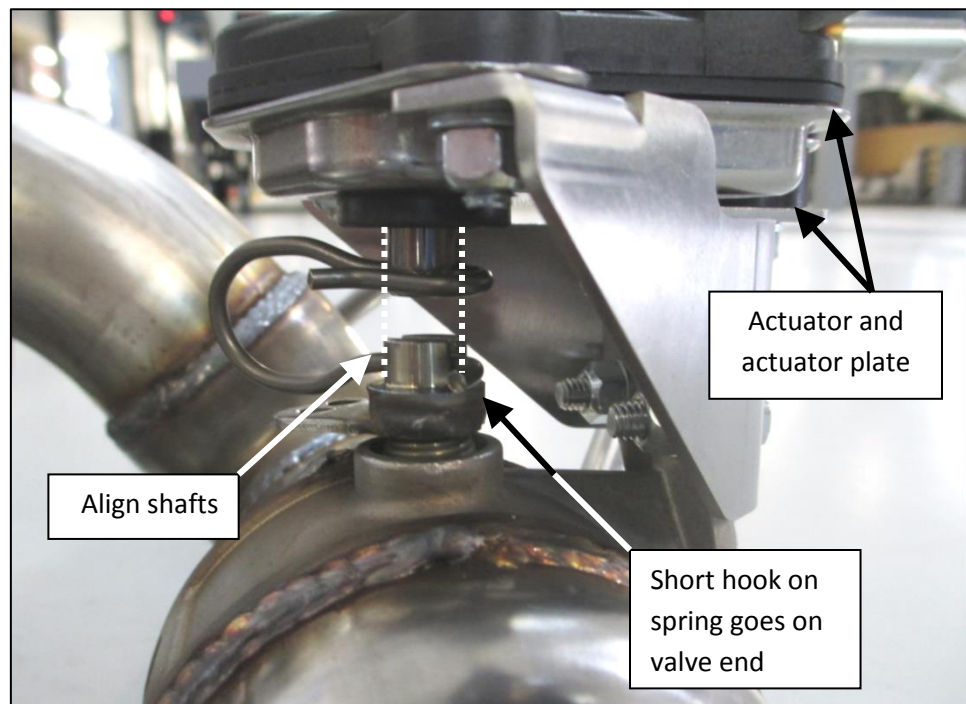

**DINAN Exhaust Valve Type I**

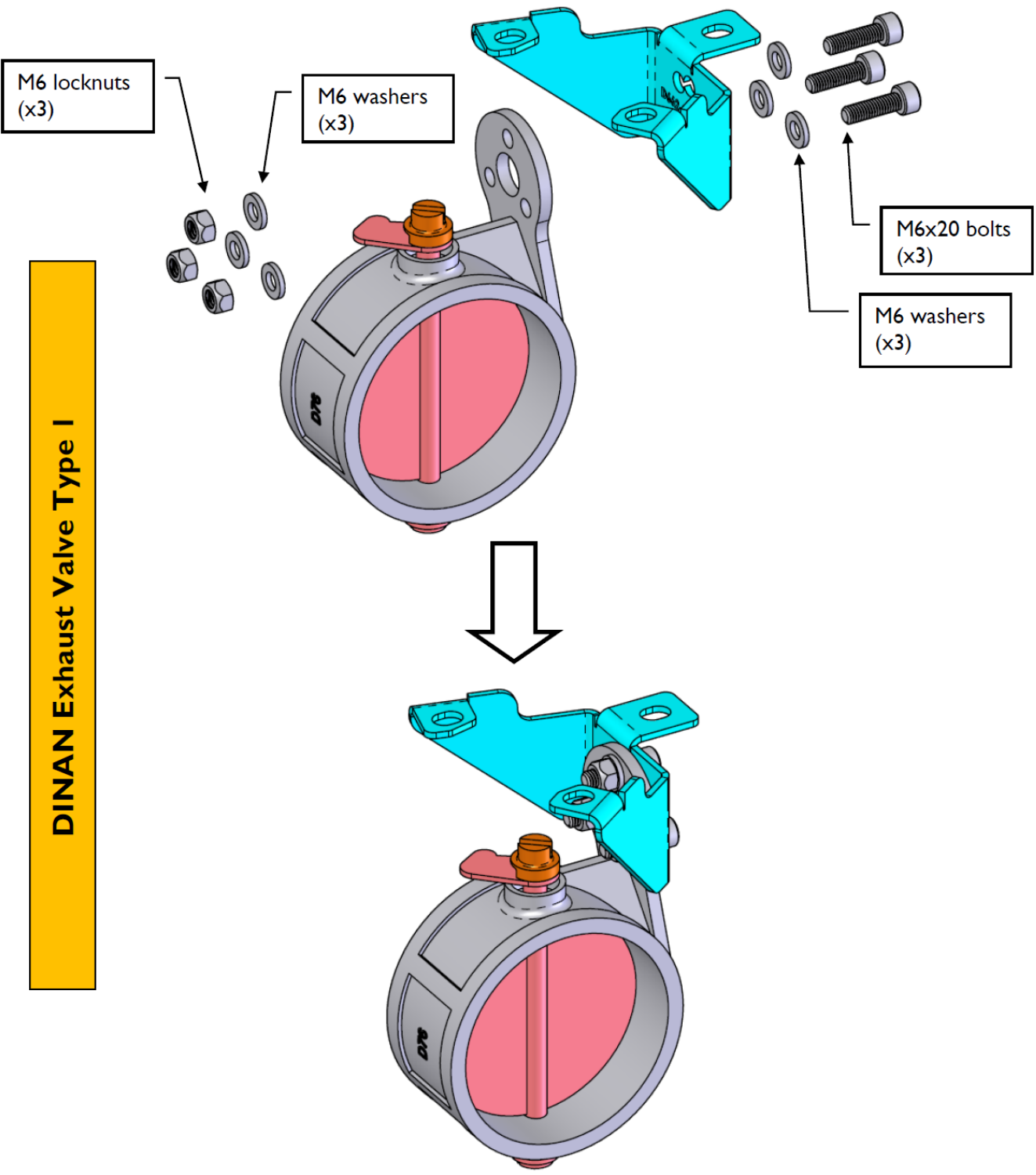

**DINAN Exhaust Valve Type I**

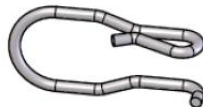
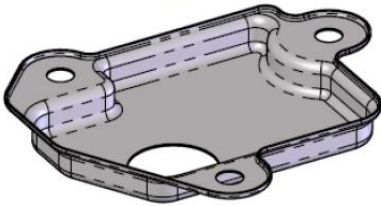
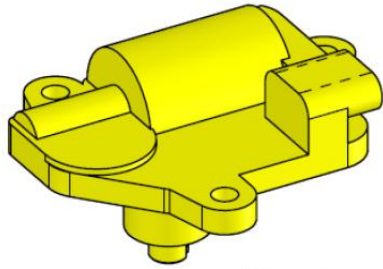
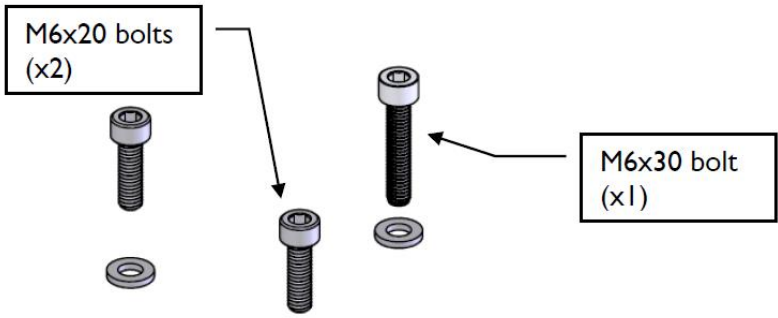

Spacer

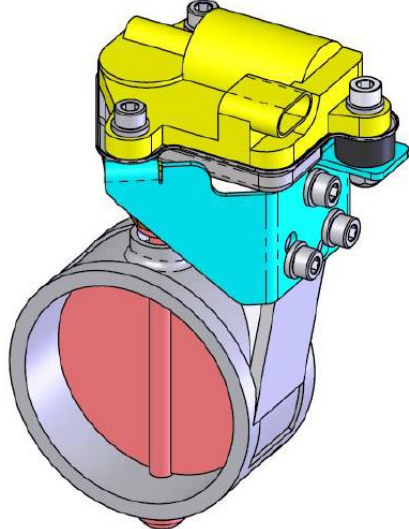
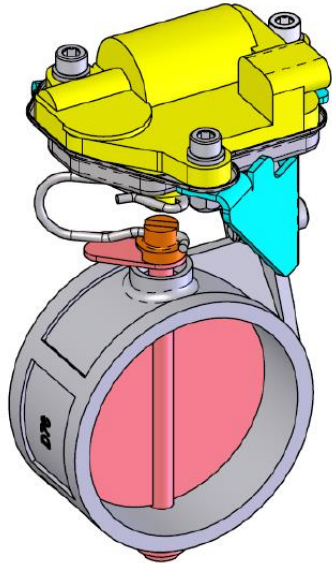
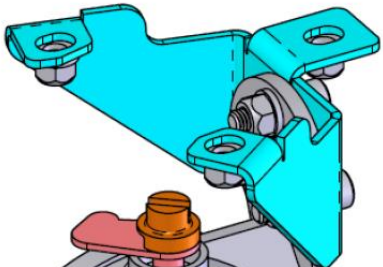
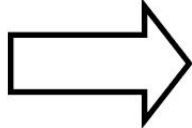

DINAN Exhaust Valve Type 2

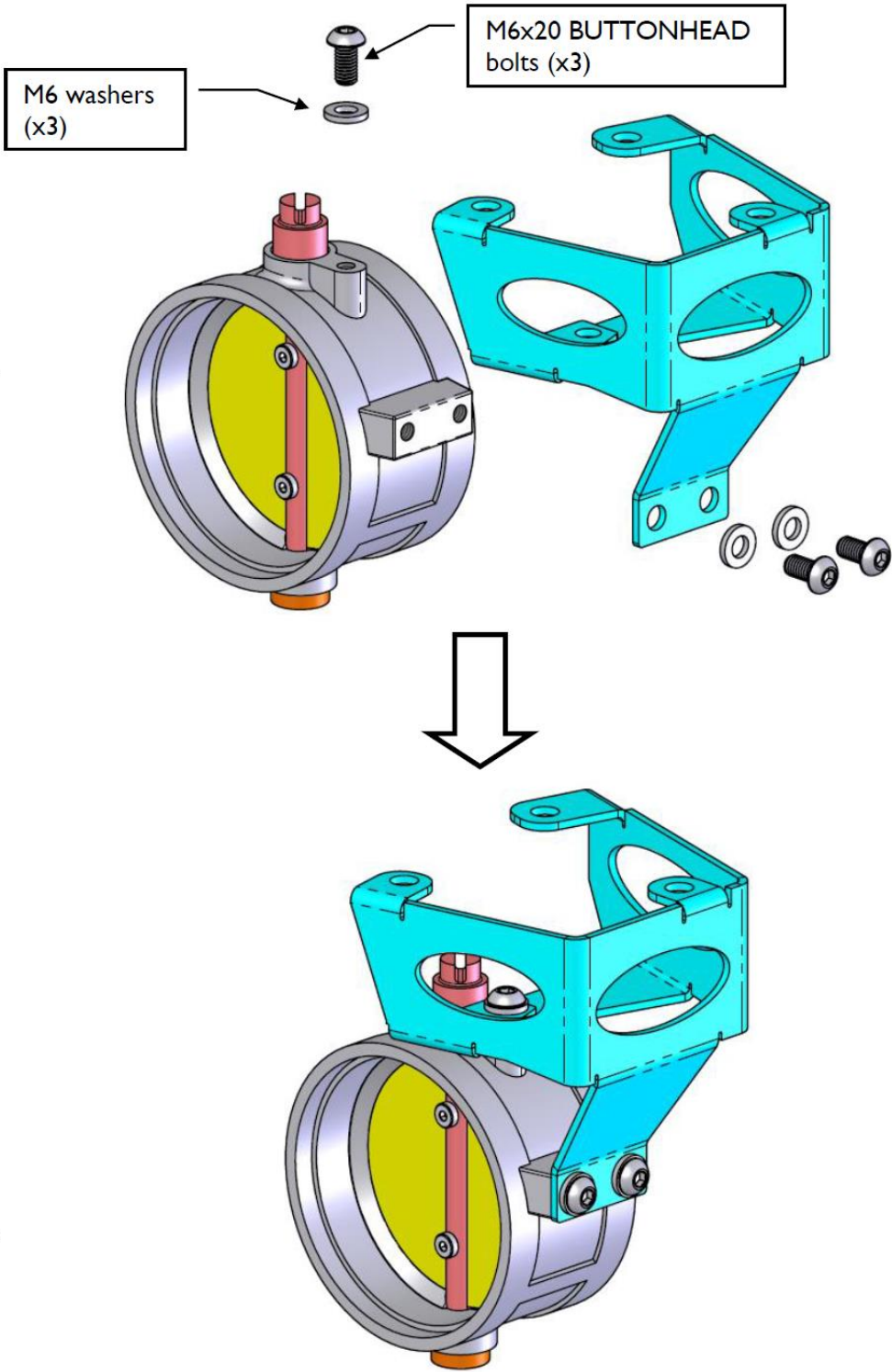

DINAN Exhaust Valve Type 2

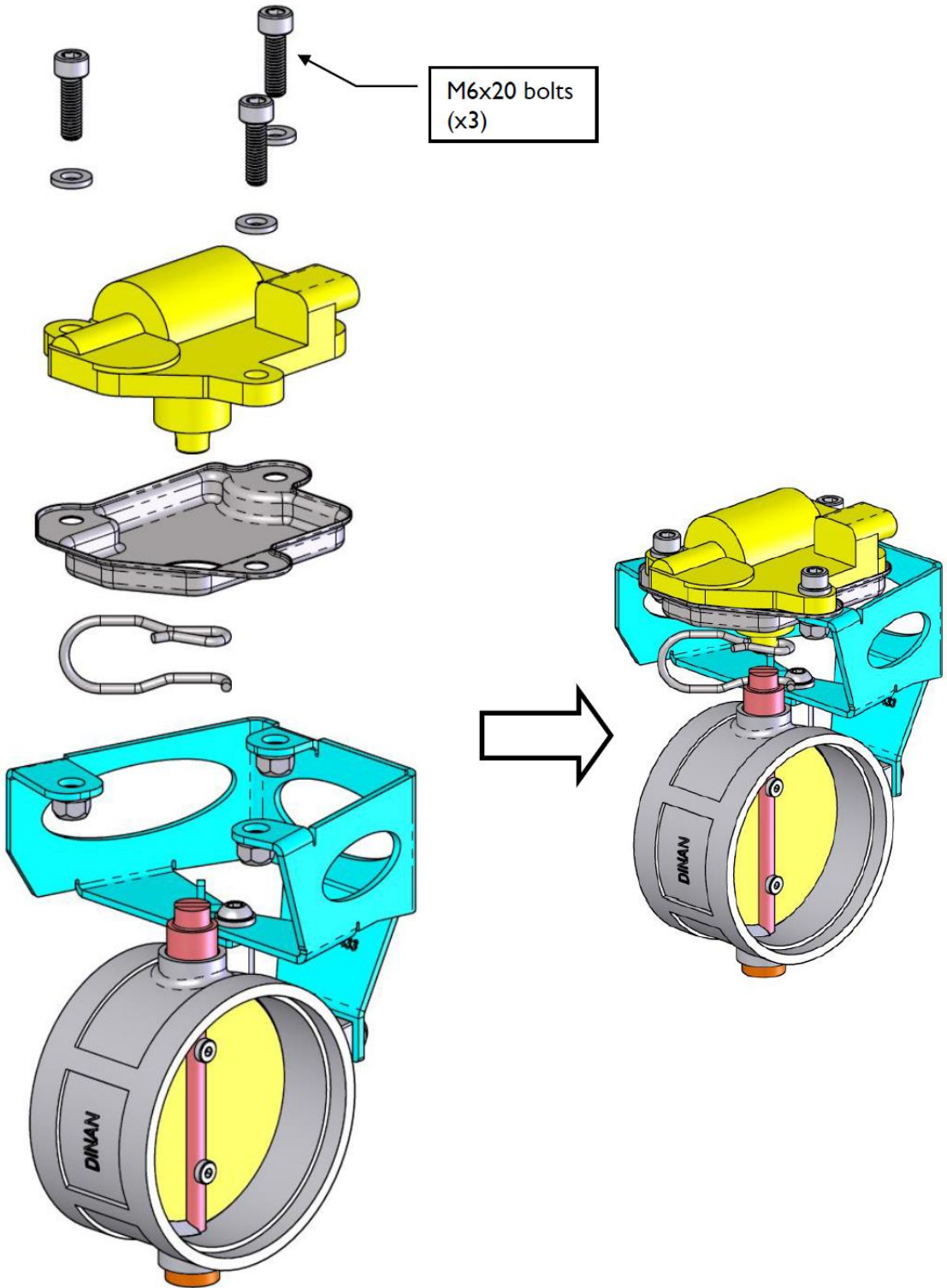



6. Install stock hangers onto DINAN muffler.

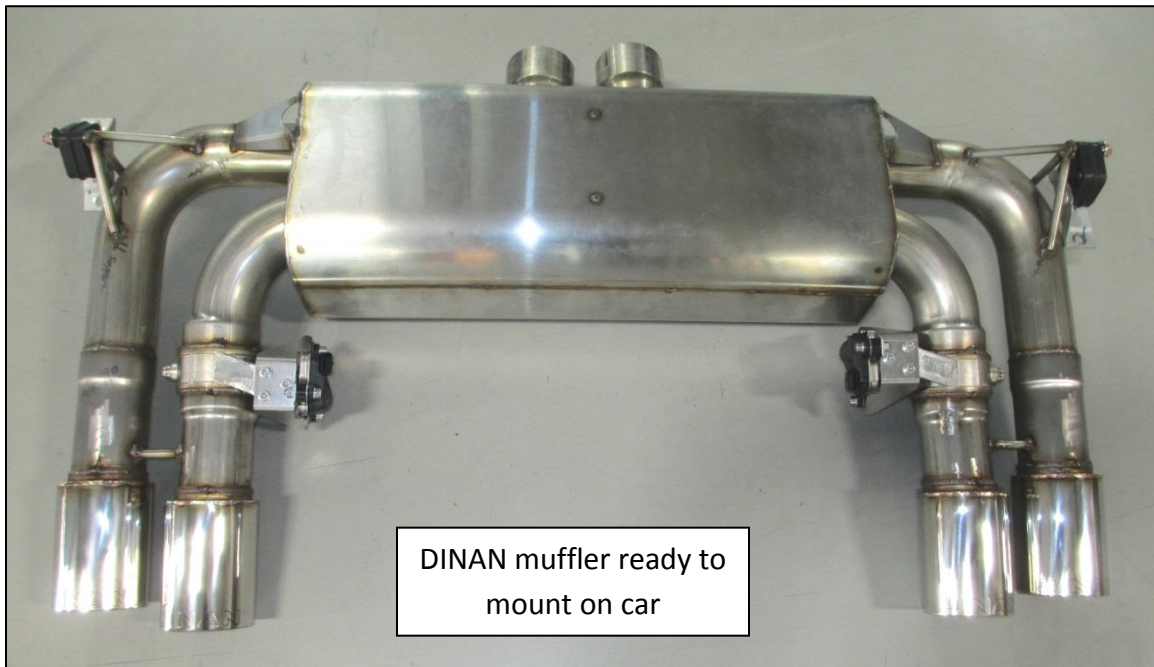

7. Place the clamps provided in the hardware kit onto the stock exhaust tubes.



8. With the DINAN muffler secured on a jack or stand, put the muffler into place. When mounting the muffler it should be held with the tips up near the bumper and the muffler pushed forward over the stock exhaust tubes.



9. Mount both muffler hangers using the (4) mounting nuts that were saved from removal of the stock muffler. Torque the nuts to **14 ft-lbs (19 Nm)**. Connect ground strap from its stock position to the allen bolt on the DINAN muffler using the nut provided in the hardware kit.

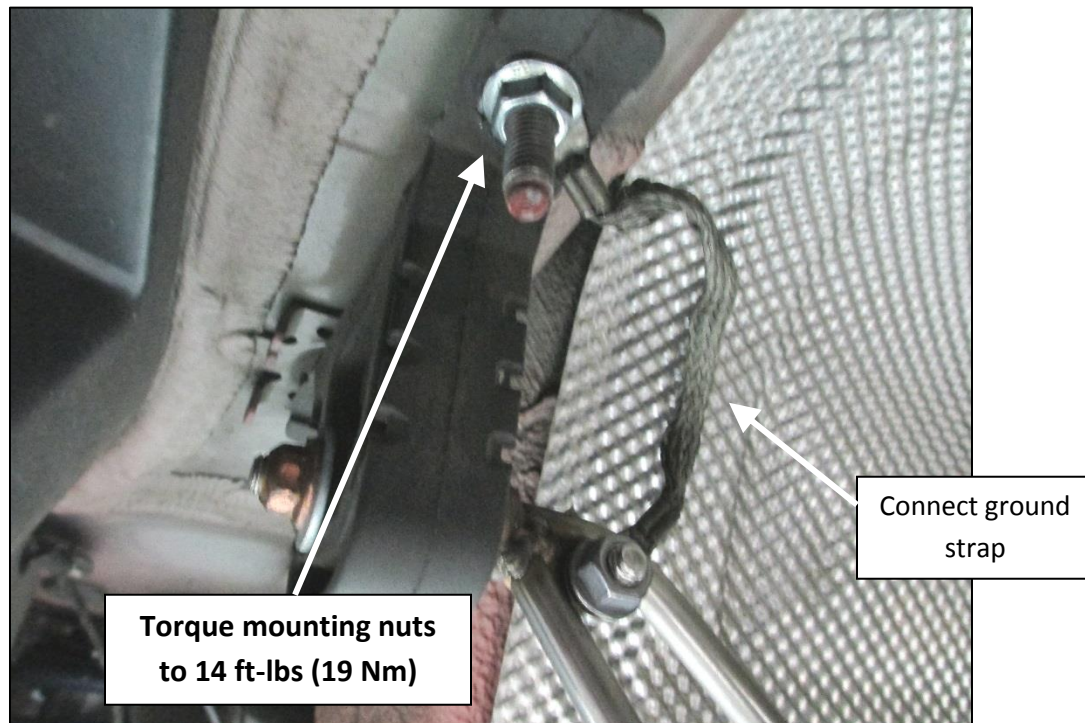

10. With exhaust clamps rotated as shown, torque clamps to **45 ft-lbs (61 Nm)**.

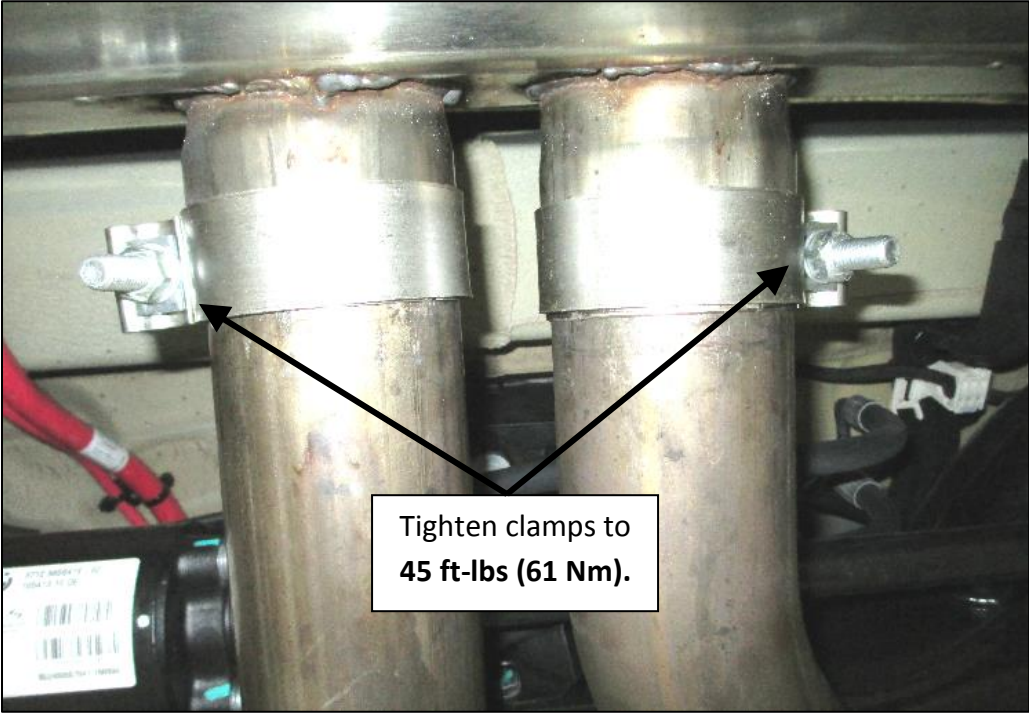

11. Connect plugs to both valve actuators. Re-route wires using the zip-ties provided in the hardware kit if needed.

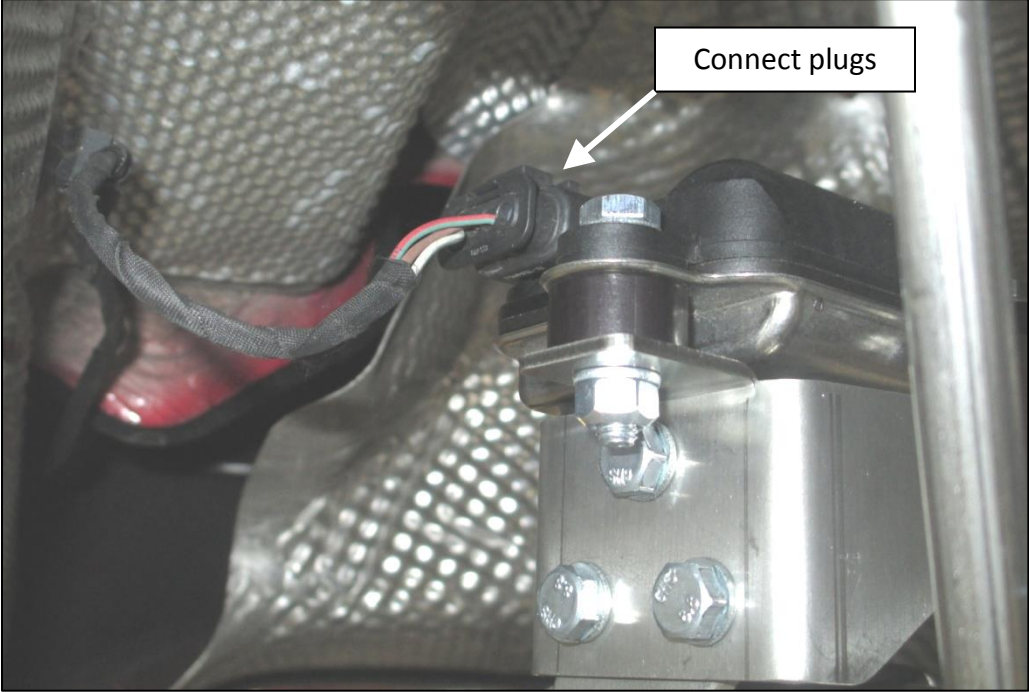

12. Check the muffler for proper bumper clearance and proper alignment using **Figures 4 & 5**.

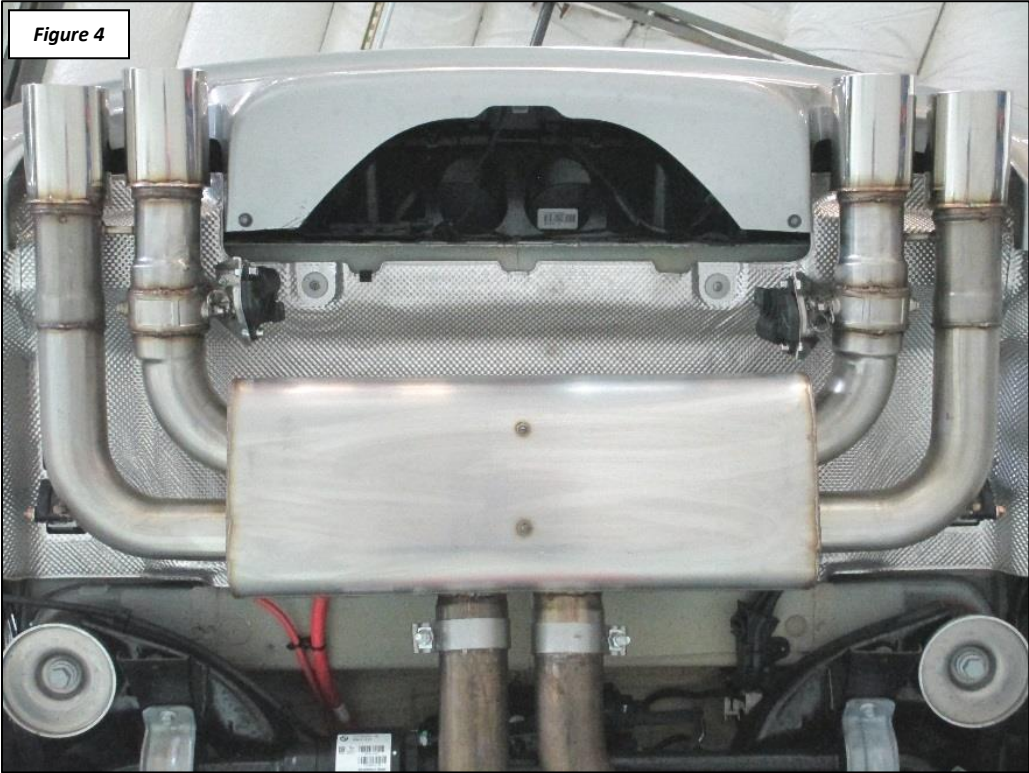

Enjoy your new DINAN exhaust!

## PARTS LIST

<u>Qty</u>	<u>Part No.</u>	<u>Description</u>
1	D663-0285	Muffler Assembly X5M
1	D663-0287A	Hardware Kit
	Contains:	
4	D502111	4" Tie Strap Black
2	D662-9237	3.00" Clamp
2	D663-0433	Valve Mount
7	D671-0189	M6 Locknut; Oval
6	D671-0193	M6 x 20 Socket Head
6	D671-0377	M6 x 12 Button Head
18		M6 Flat Washer
6		M6 Wave Washer