

Installation Instructions

D660-0082(-BLK): 2019-20 F87 M2 Competition Exhaust

Document Revision: C
Release Date: February 17, 2023

Table of Contents

Parts List	2
Removal of Stock System	3
Installation of Dinan System	7

Thank you for being selective enough to choose a Dinan Performance Exhaust System. The Dinan team has spent many hours developing this product to assure that you will receive increased performance, durability and an aesthetic design that you as a customer will be able to enjoy for many years. Ease of installation and maintenance is important to us and has been highly considered throughout the design process.

Prior to performing the installation, familiarize yourself with these instructions as it should help you with the process. If you feel that you do not have the required skills or tools, please arrange for a qualified repair facility to perform the installation.

If you have any difficulties during the installation, or if these instructions are not clear to you, please call Dinan's Technical Support Staff at (800) 341-5480.

Again, thank you for choosing Dinan. Enjoy.

Parts List

Quantity	Part #	Description
1	D663-0348	Muffler Assembly
4	D663-0600 or -0601	Exhaust Tip
1	D663-0350	Hardware Kit; contains:
2	18 30 7 620 323	Fixing Bow
2	D502121	5" Tie Strap
2	D662-0433	Valve Mount
2	D662-0615	Extension Harness
4	D662-9228	2.75" Accuseal Clamp
2	D662-9230	63.5mm Clamp
2	D662-9241	2.75" Torca Coupler
6	D671-0189	M6 Locknut Oval
6	D971-0193	M6x20 Socket Head Screw
6	D671-0377	M6x12 Button Head Screw
18	M6 Flat	Washer
6	M6 Wave	Washer

Removal of Stock System

1. Removing the Brace:

- Remove the six bolts that hold the center brace to the car.
- Slide the center brace out from under the other braces.
- Support the muffler securely with a jack stand.

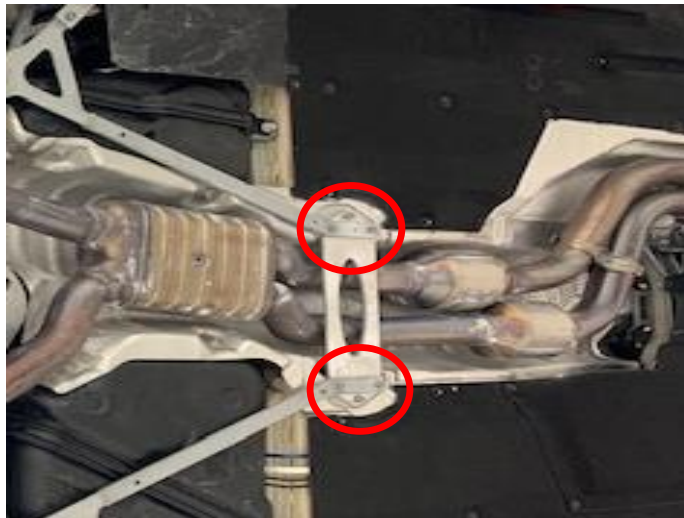

2. Cutting the exhaust:

- Driver side – measure 6-5/8” from weld point on catalytic converter. Make a mark.
- Passenger side – measure 6” from the weld point on the catalytic converter. Make a mark.
- Make your cuts according to these two marks.

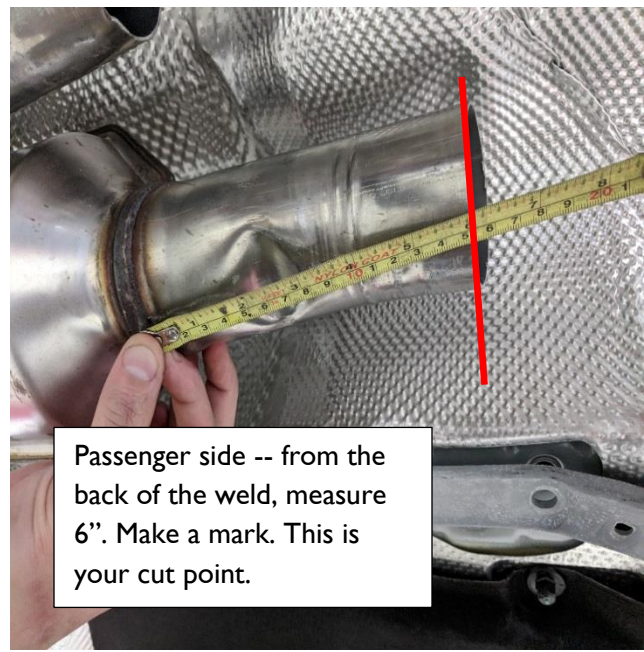
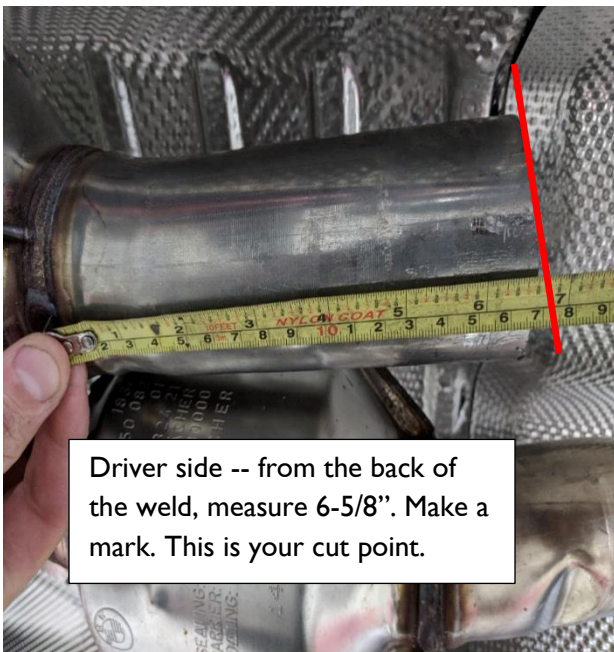

3. Remove the stock exhaust from the car:

- Unplug both of the exhaust valve motors.
- Unbolt the four hangers from the car. Remove the stock exhaust from the car.

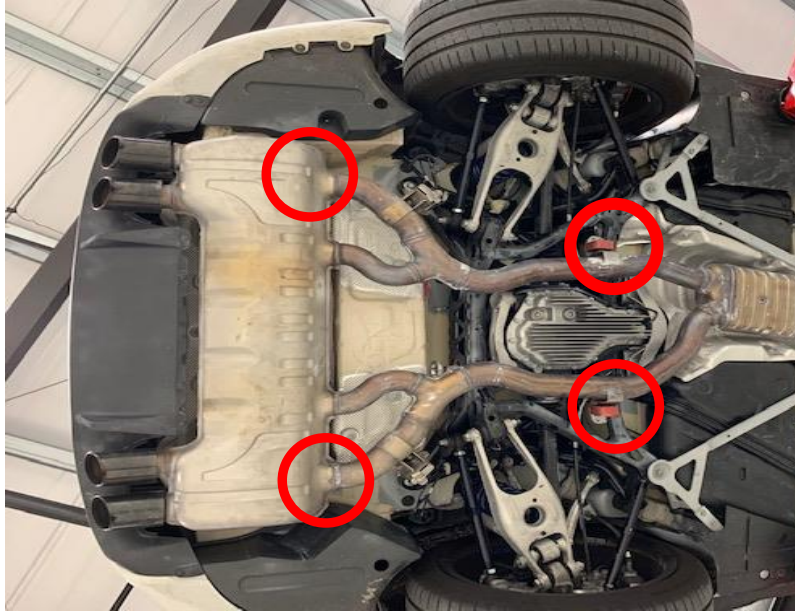
**4. Removing the hangers:**

- Remove the two hangers from the muffler.
- Keep track of which side they come off of and their orientation.
- Install them onto the Dinan muffler.
- Repeat with the two hangers on the X-Pipe.



- Following the diagrams below, attach the actuators, brackets, and springs to the Dinan exhaust valves using the hardware provided.

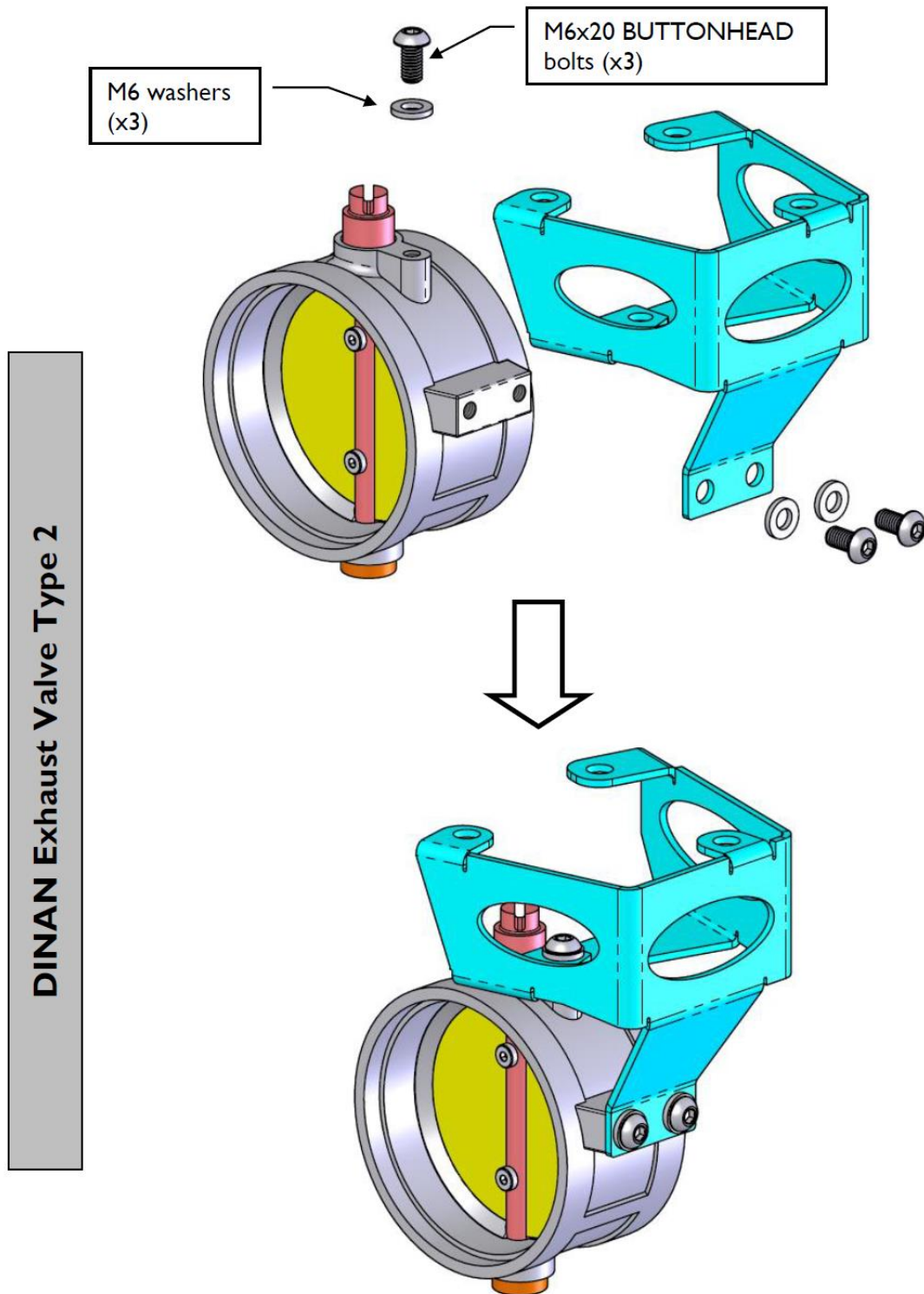

DINAN Exhaust Valve Type 2

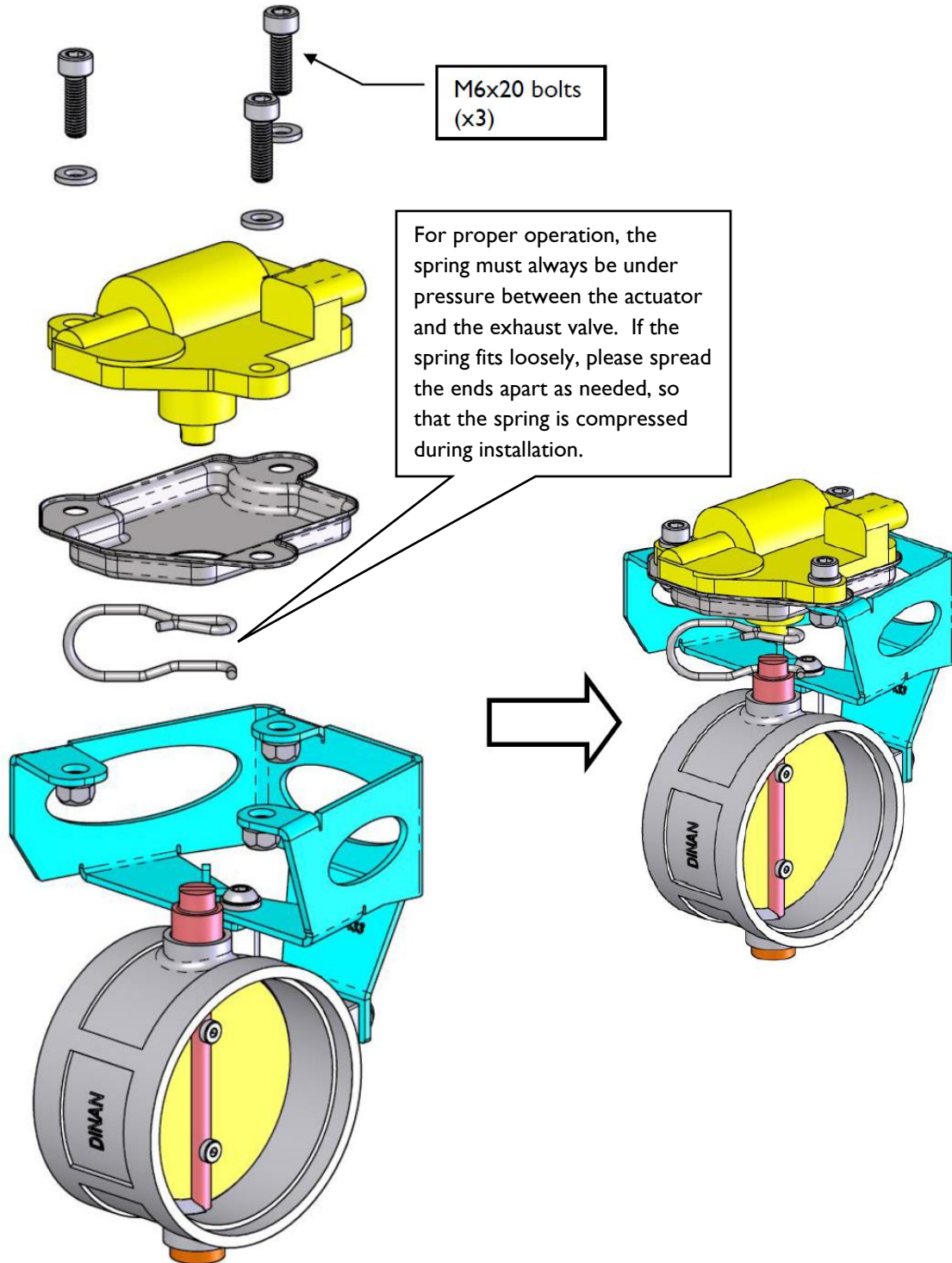

Installation of Dinan System

6. Prepping the X-Pipe:

- Slip the two 63.5 mm single bolt clamps onto the exhaust.
- Make sure the bolts are facing inward as shown below.
- Make sure both hangers are installed on the X-Pipe, before installing on vehicle.

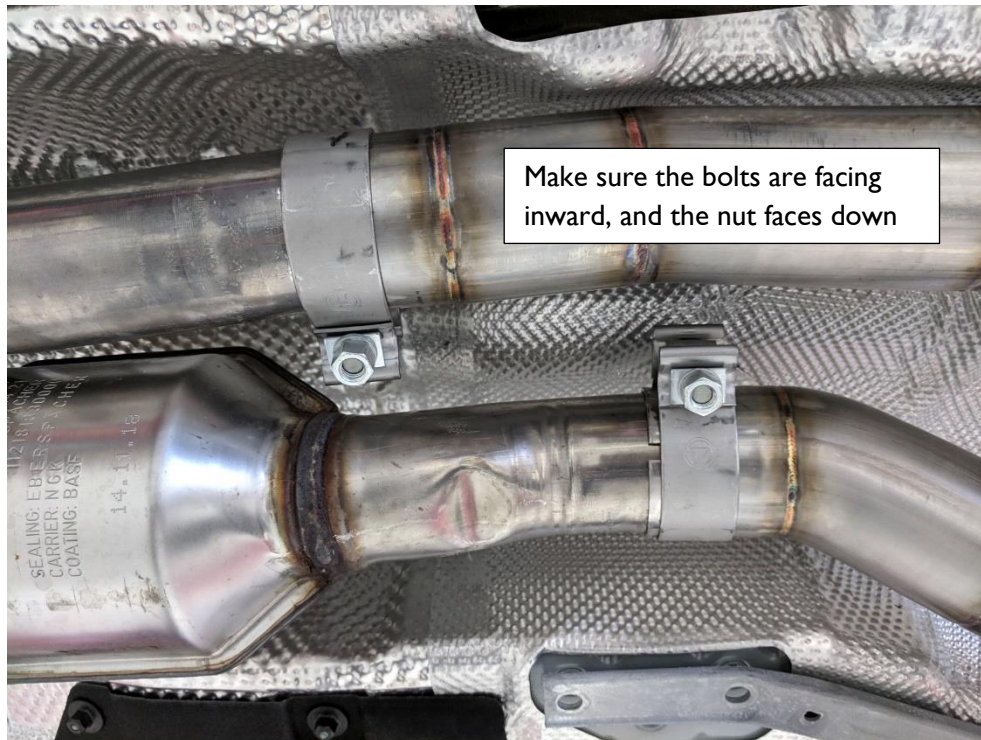

7. Installing the X-Pipe on to the car:

- Slide the X-Pipe assembly on to the exhaust where the cuts were made.
- Attach the 2 hangers to help support the X-Pipe assembly.



8. Verify clearance:

- With the X-Pipe in place, you will need to make sure you have clearance everywhere.
- When you have a good fitment, go ahead and snug the clamps (do not fully tighten at this time).



9. Installing the Dinan Muffler:

- Slip the 2-bolt coupler clamps on to the X-Pipe, with the bolts facing outwards.
- Make sure you have both hangers on the muffler assembly.
- Lift the muffler into place, slipping both inlet pipes into the clamp
- Install and tighten the two nuts for the hangers to the underside of the car.

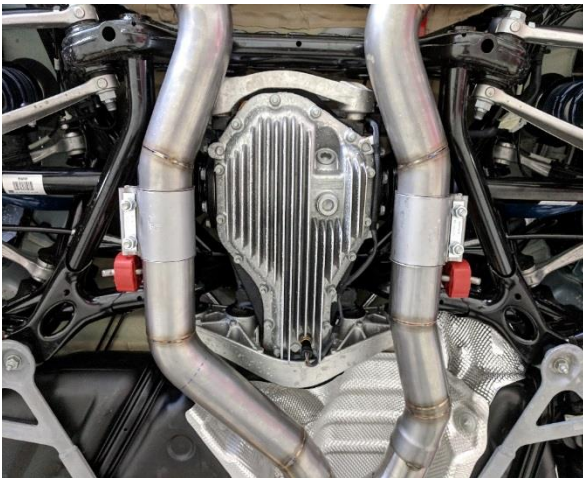
**10. Adjusting the muffler assembly:**

- With an assistant, push the exhaust up and towards the front of the car. Move the outlet tubes side to side until they are centered in the exhaust cutouts.
- Snug the clamps (do not fully tighten at this time).
- Note: You may need to readjust again after you install the tips.

II. Installing tips and adjusting:

- Slip the four 69.9mm clamps on to the tips.
- Starting with the inner tips, slide the tip onto the outlet pipe, with the clamp bolt facing outward.
- Locate the inner tips 1" inboard of the bumper edge, as shown below.
- Slip on the outside tips, and stagger them about 1/2" forward of the inner tips, as shown below.
- There should be about a 1/4" gap between the inner and outer tips.
- Make sure that the N in the middle of the logo is centered as shown below.
- Snug the clamps (do not fully tighten at this time). You will do this with all the tips on both sides.

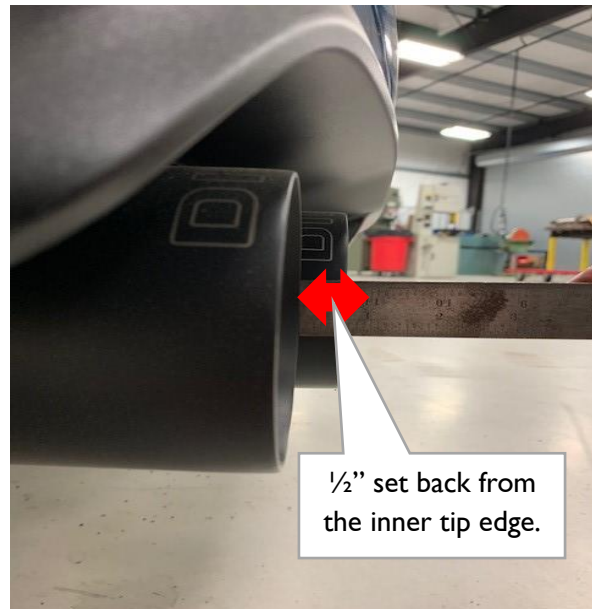
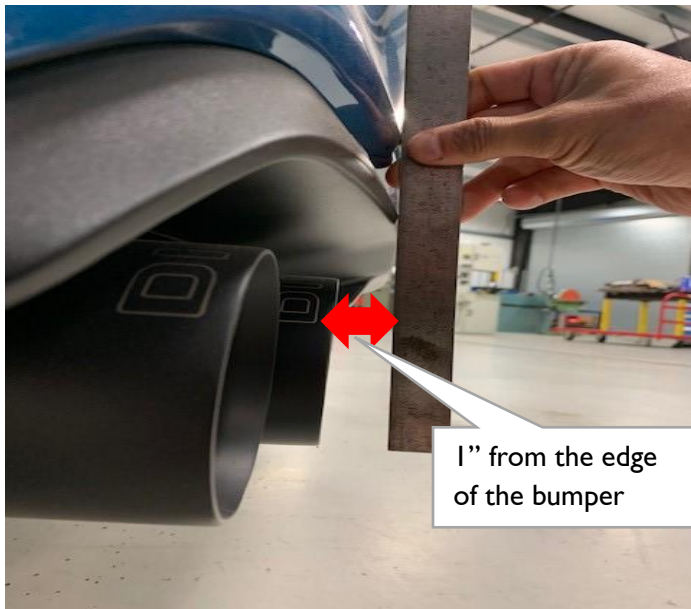
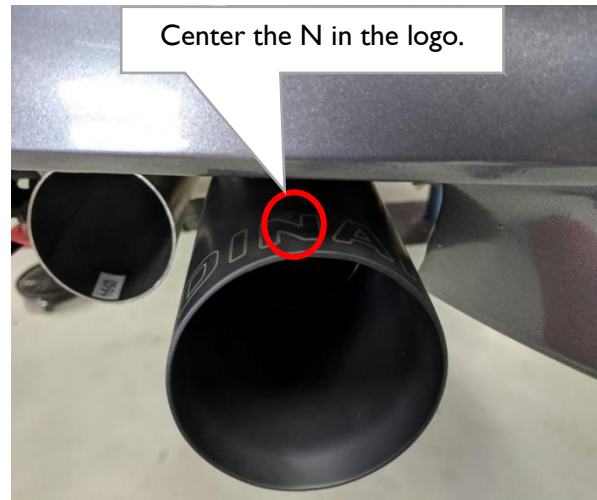

12. Verify the tips are centered:

- Lower the car down.
- Stand back and look at the exhaust tips.
- If the tips are not centered in the cutouts, readjust the exhaust. Repeat as necessary.
- Once you are satisfied with the tip locations, torque all the clamps to 45 ft-lbs.
- Raise the car back up and reinstall the center brace.

**13. Installing the wiring harness:**

- Plug the female end of wire harness into the car harness.
- Plug the male end in to the motor on the muffler assembly.
- Repeat on other side.
- Use the provided Zip-Ties to secure the cables out of the way.
- Ensure there is some slack in the harness so the wires are not under tension.

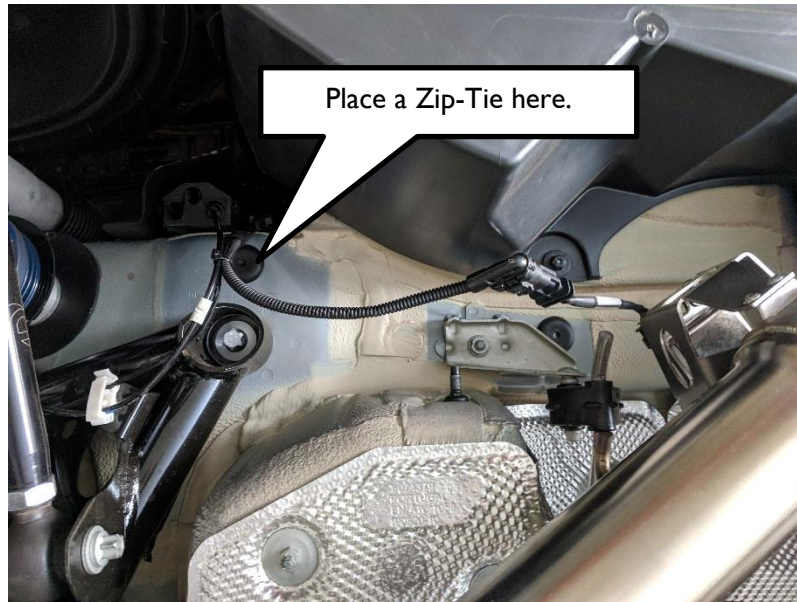
**14. Test driving the car:**

- Get the exhaust hot to make sure the packing bags inside the muffler have popped open. There may be a little smoke coming out of the pipes, this is normal.
- Carefully examine the installation and verify adequate clearance at all locations.
- Adjustments if needed.

Enjoy your new Dinan Performance Exhaust!