



## HIGH PERFORMANCE HEAT EXCHANGER INSTALLATION INSTRUCTIONS

PART NUMBER D780-0001A

APPLICATION: 2015-18 F80 M3  
2015-19 F82/F83 M4  
2019 F87 M2 Competition

Congratulations for being selective enough to use a Dinan High Performance Heat Exchanger Kit. We have spent many hours developing this kit to assure that you will receive maximum performance and durability with minimum difficulty in installation. Please take the time to read these instructions and call us if you have any difficulties during the installation.

---

### PARTS LIST

Qty	Part #	Description
1	D783-0021A	Dinan Heat Exchanger Assembly
1	D783-0020A	Hardware Kit

---

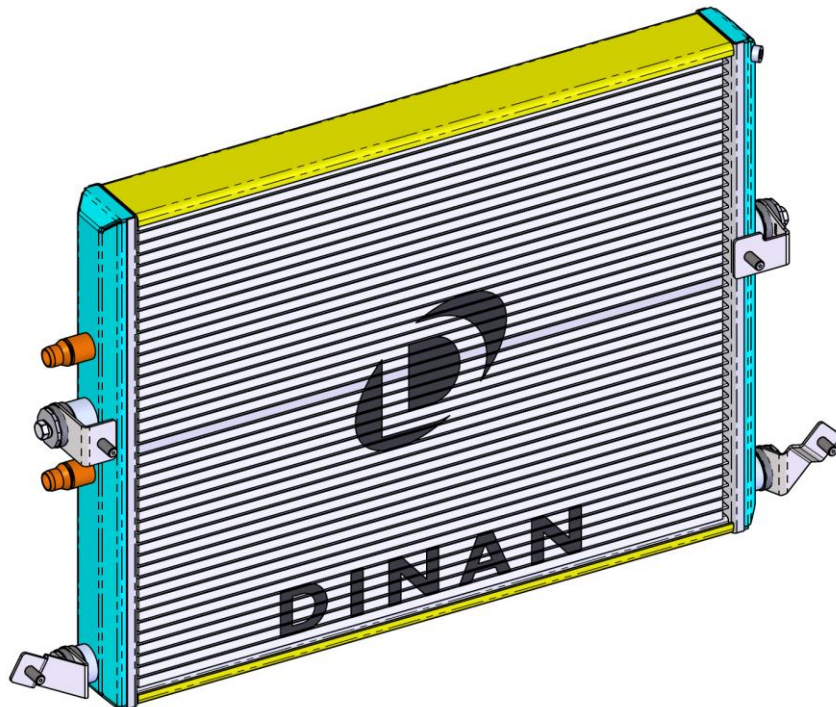

## INSTALLATION:

1. Remove the front bumper per BMW recommended procedure.
2. Drain coolant from intercooler system:
  - Remove the cap from the coolant reservoir for the intercooler.
  - Place a drain pan under the secondary cooler on the passenger side of the car (see photo below). This cooler is part of the after cooler system.
  - Remove the clip that locks the lower hose onto the secondary cooler.
  - Pull off the hose and let the coolant drain.
  - Once all the coolant drains out, reattach the hose and reinstall the clip.

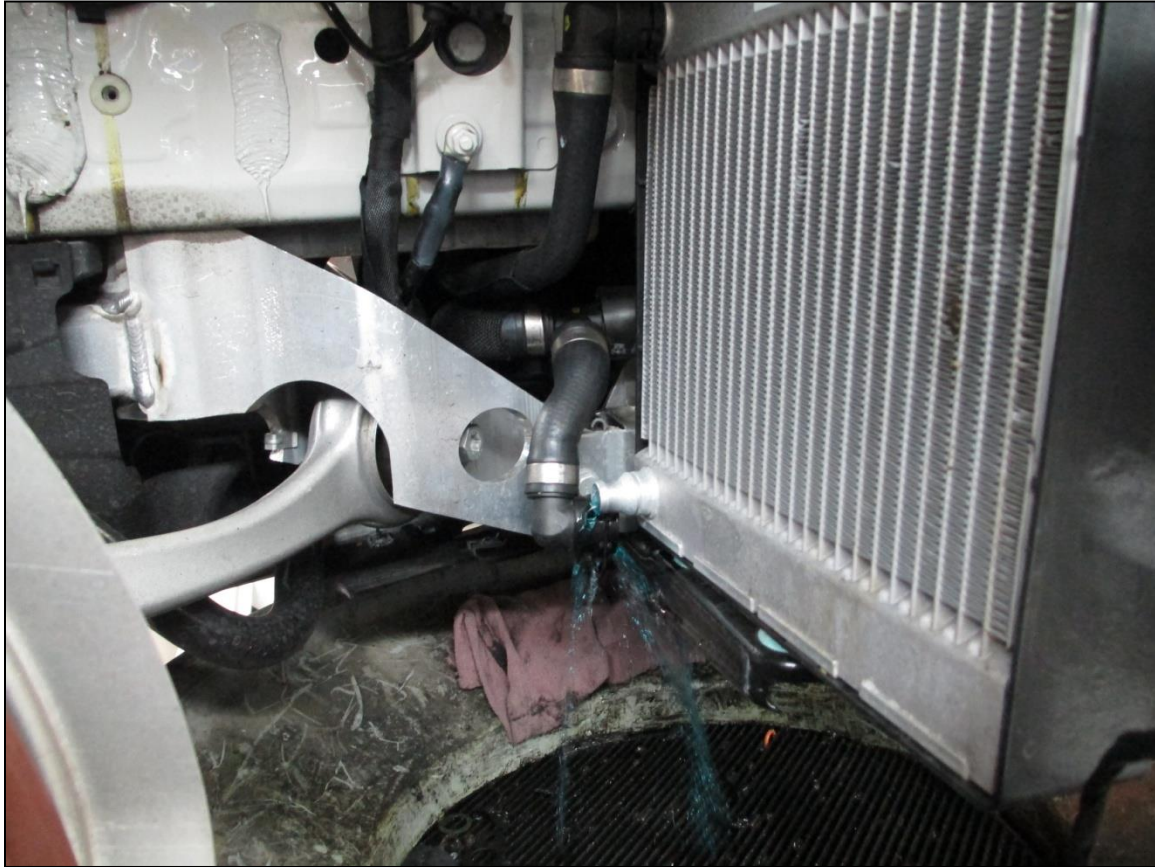

3. Remove the four bolts that attach the bumper beam to the vehicle, and set it aside. Note that the bolts can be removed with the headlight in place.

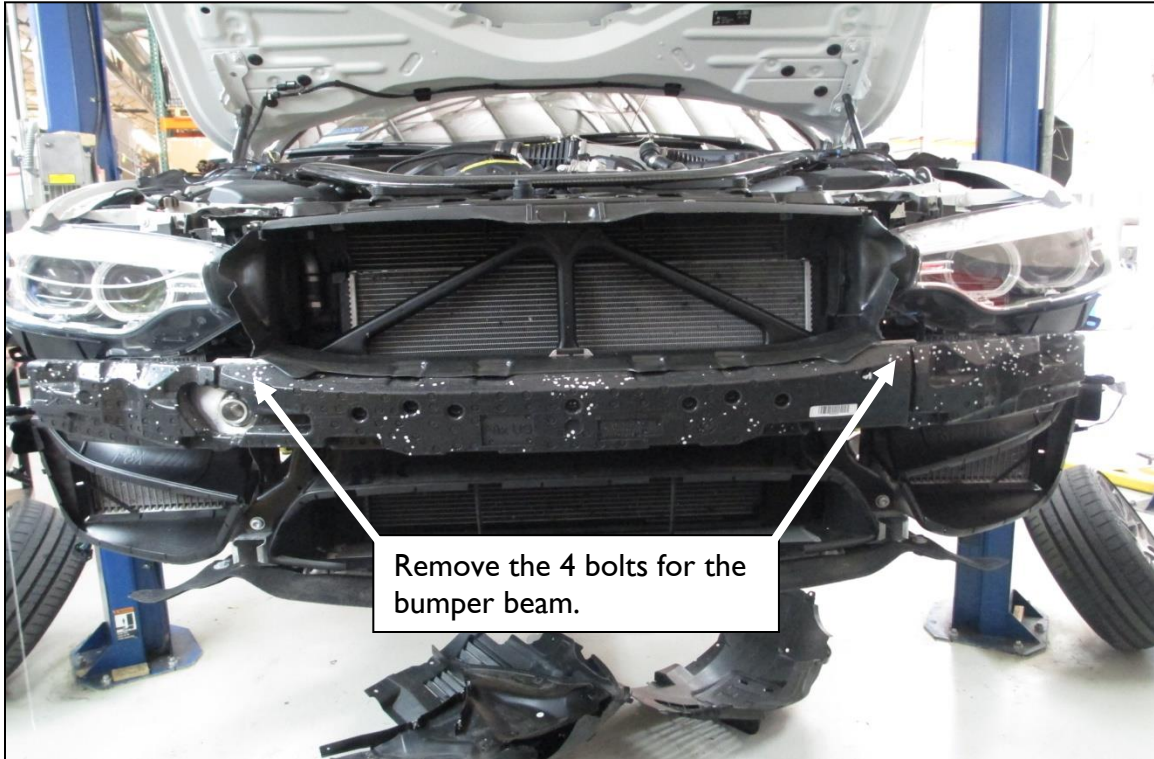

4. See photos below. Remove the lower air duct by unclipping the 6 tabs and 2 push pins.

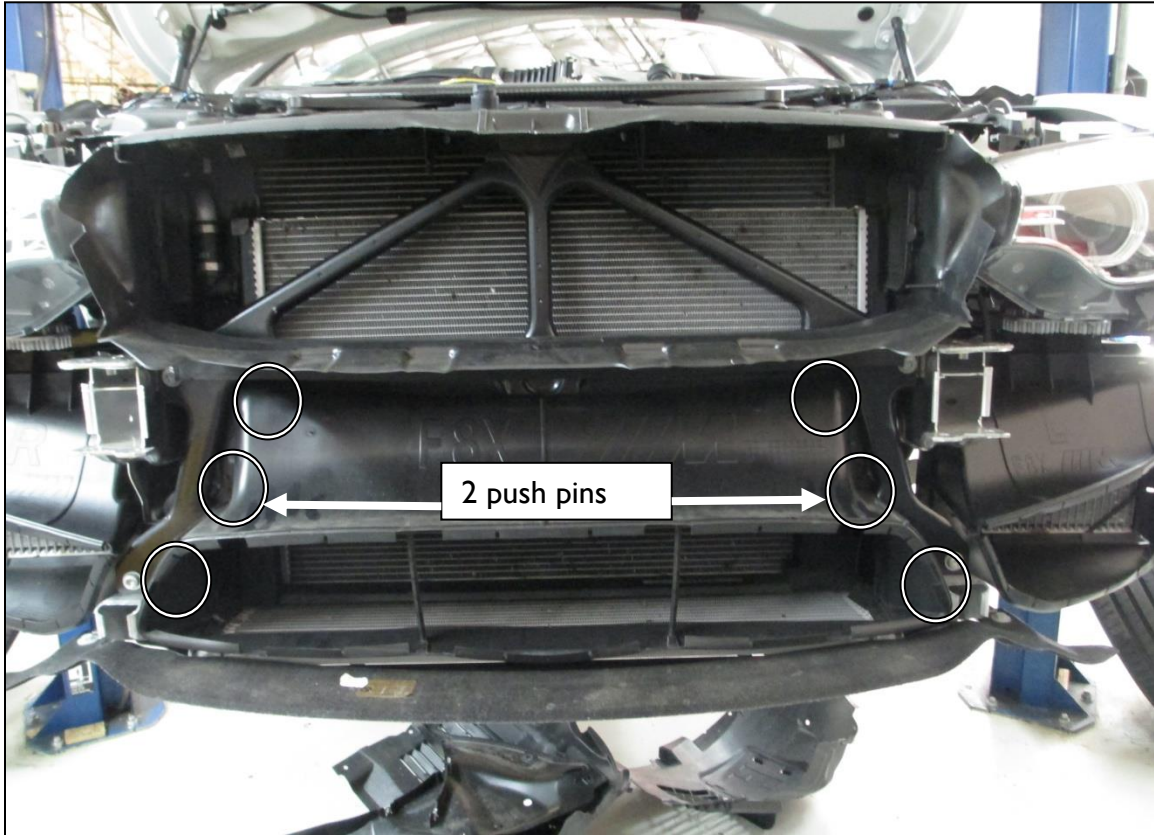

5. Remove the 6 bolts that secure the front brace (the top 2 bolts come in from the top of the car), and remove brace from vehicle. Take care to prevent damage to the fins on the after-cooler as you slide the brace past the upper air duct.



6. Remove the 2 clips which lock the coolant hoses onto the after-cooler and disconnect the hoses. Note -- coolant will spill out, so have a drain pan ready.

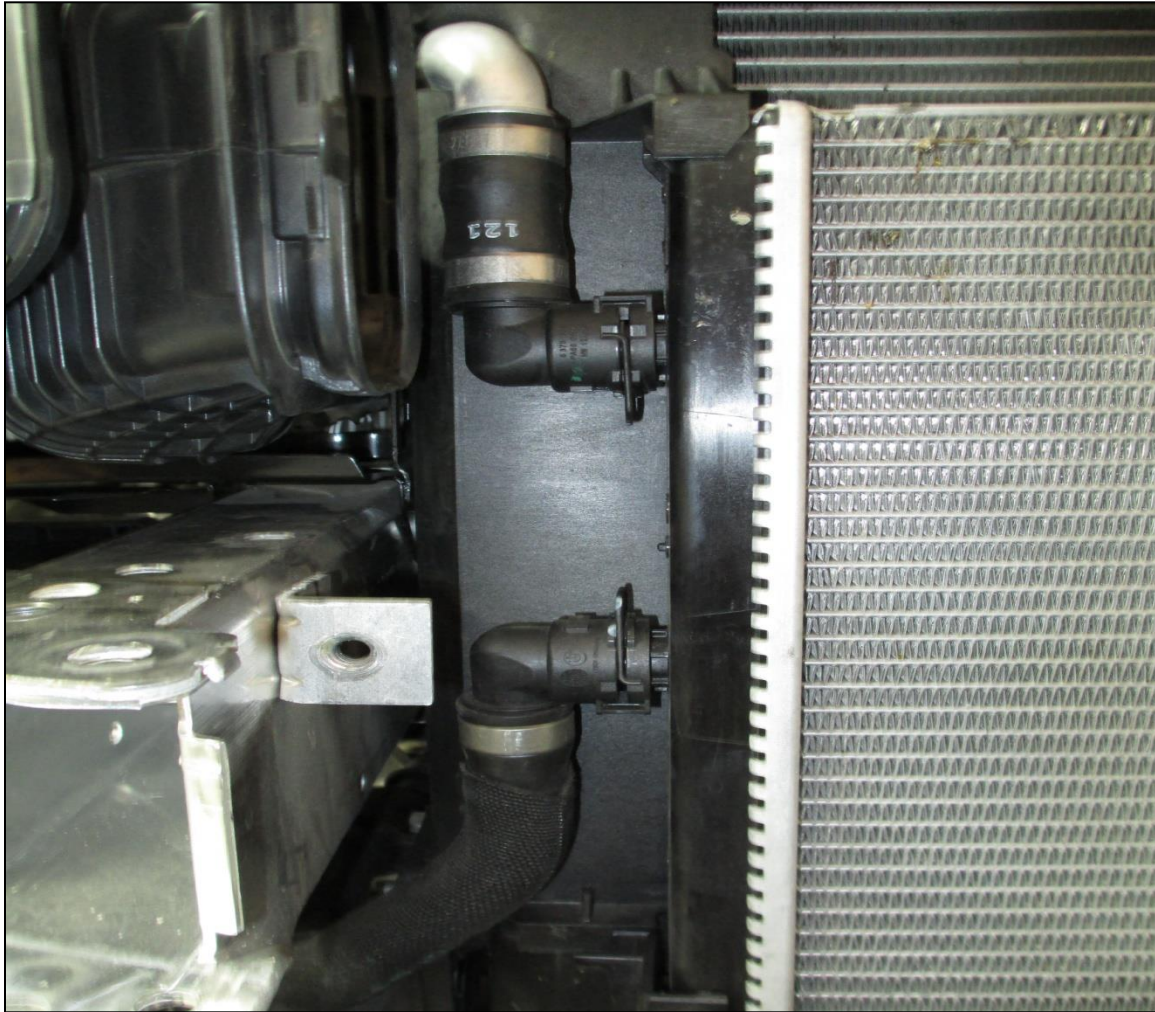

7. Remove the two plastic pieces where the lower air duct was clipped to.
- Push up to release the lower tab.
  - Remove the upper air duct.
  - Finally, release the upper tabs.

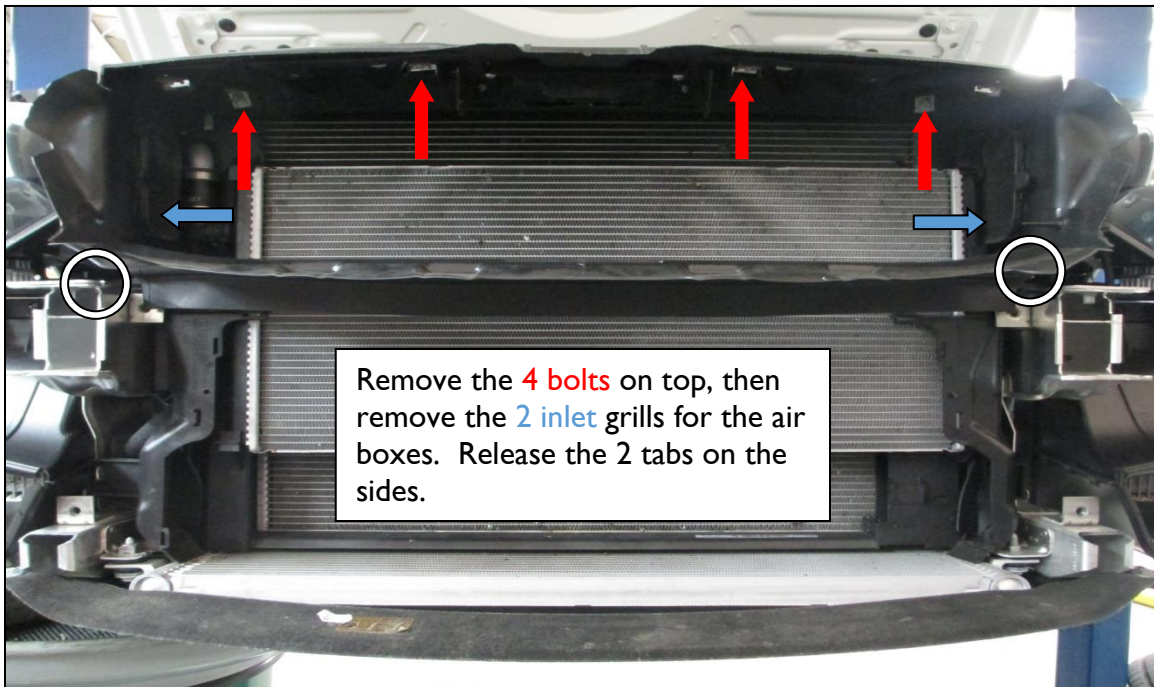
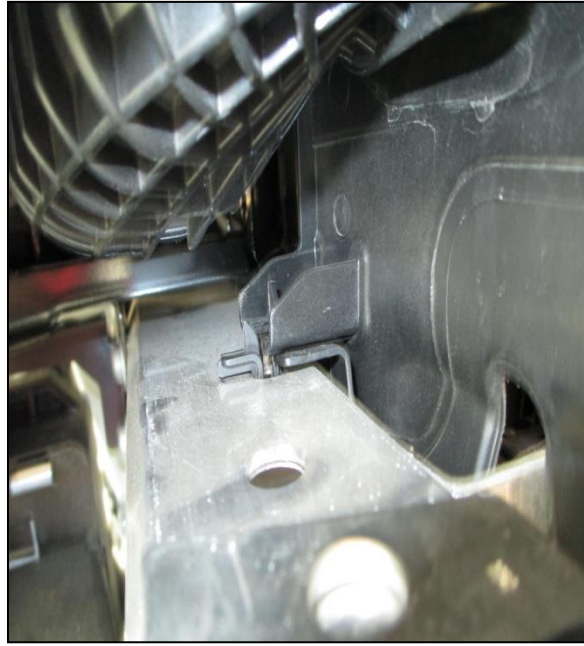
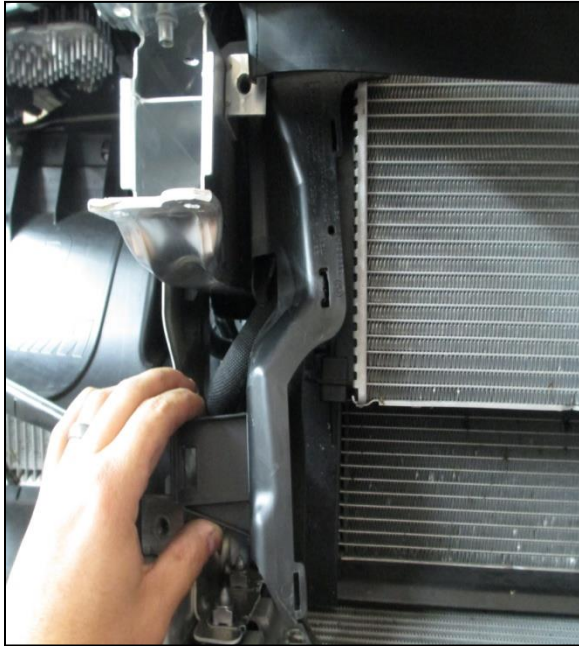

8. Remove the primary after cooler from the core support:
- Gently pull cooler towards the driver's side, while at the same time pulling outwards to release the cooler as shown below.
  - Release the tab on the driver's side using a pick.
  - Remove the cooler from the vehicle and set aside.

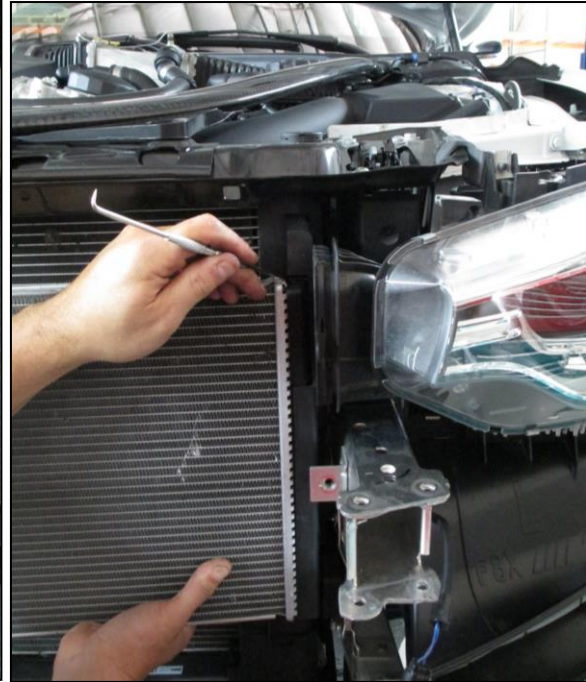
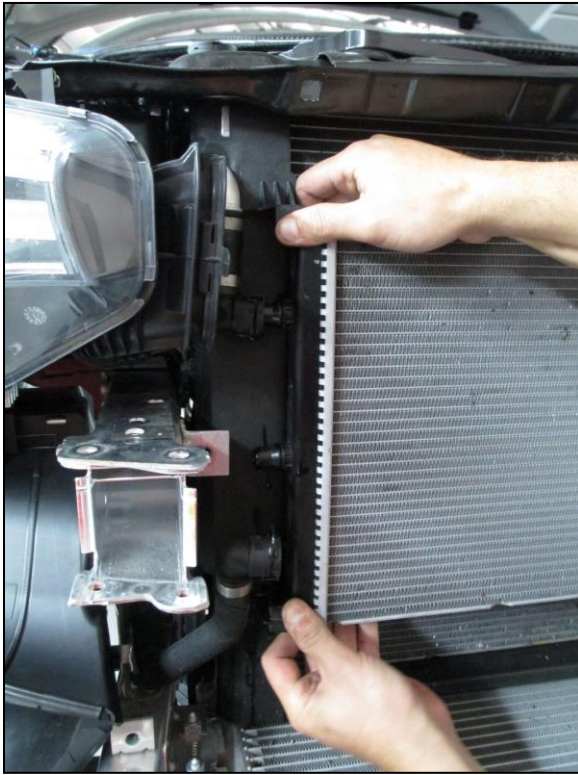

9. With the cooler removed, use a small grinder to remove the 2 tabs on the driver's side as shown.

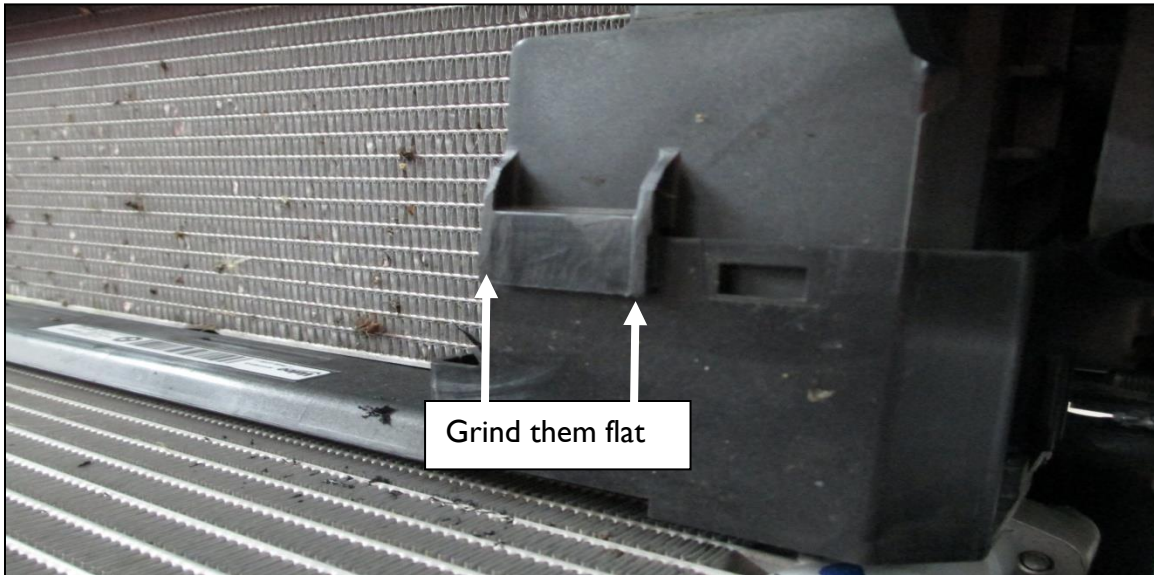



10. Install rubber mounts and metal sleeves into all of the Dinan brackets as shown.

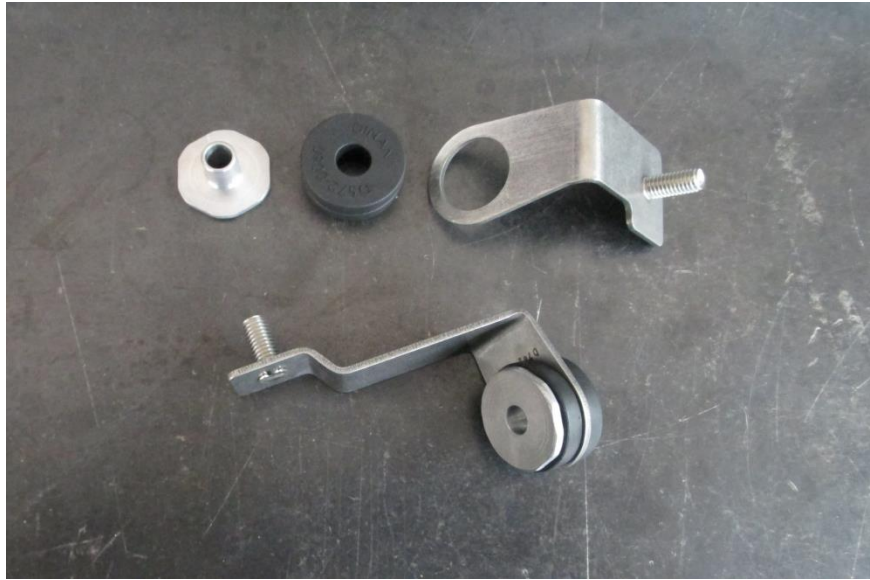

11. Using the included bolts and wave washers, install the brackets onto the Dinan cooler. Note that each bracket is unique, and must be positioned as shown.

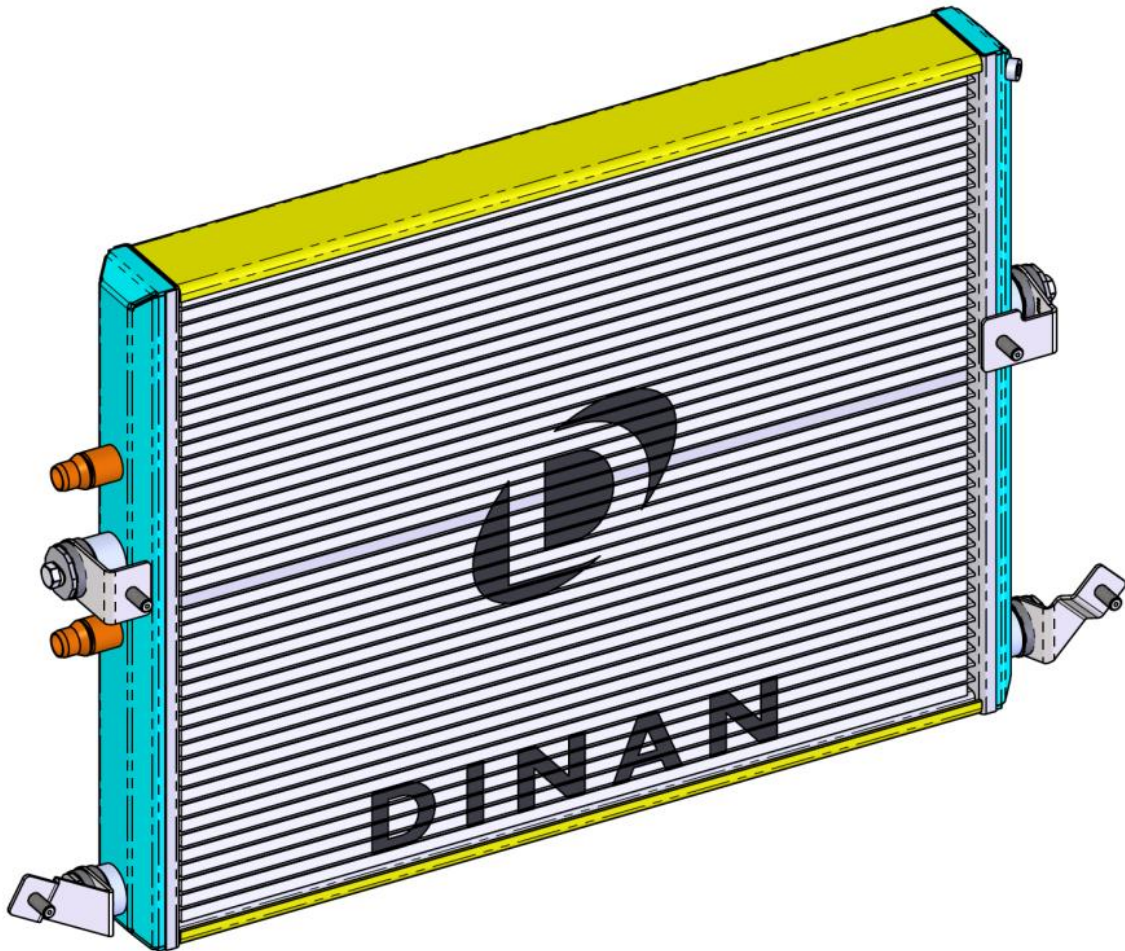

12. Install Dinan cooler into place.

- Slip Dinan cooler into position as shown.
- Examine the condition of the O-rings in the coolant lines, and replace if needed. New O-rings are included in this kit.
- Apply a small coat of lube onto the O-ring, and attach the coolant lines.
- Reinstall the upper air duct and the two lower plastic parts as well.

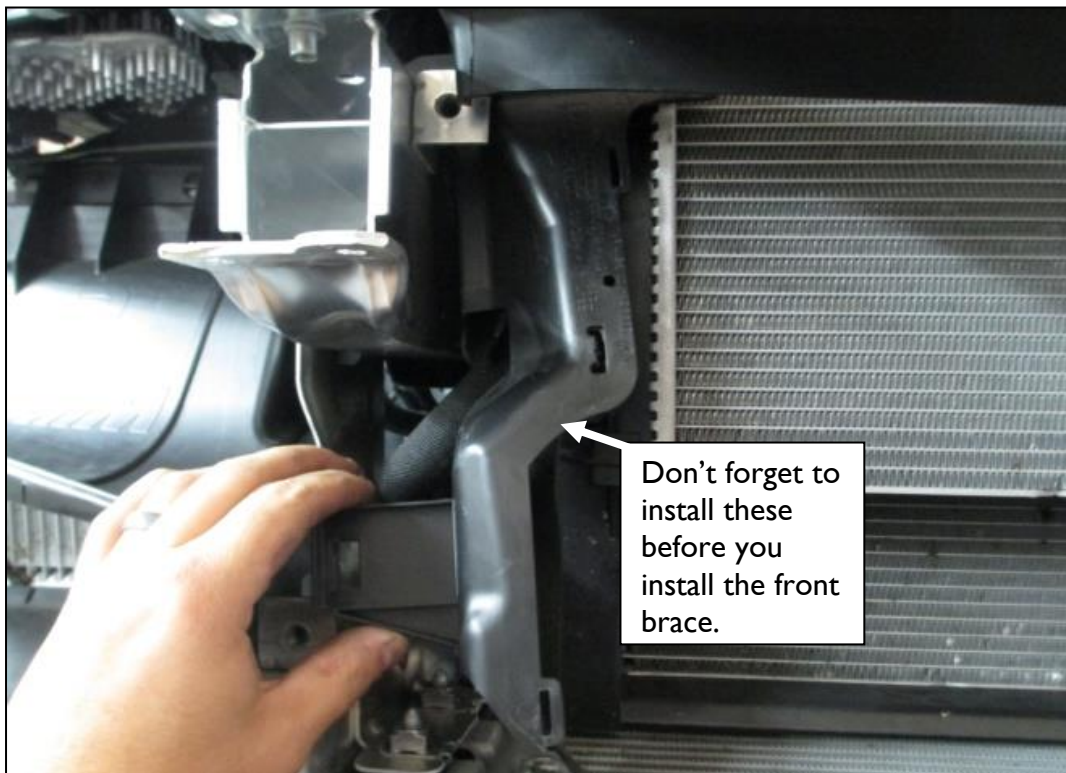

13. Drill out the indicated hole on the front brace to 8mm (or 21/64").

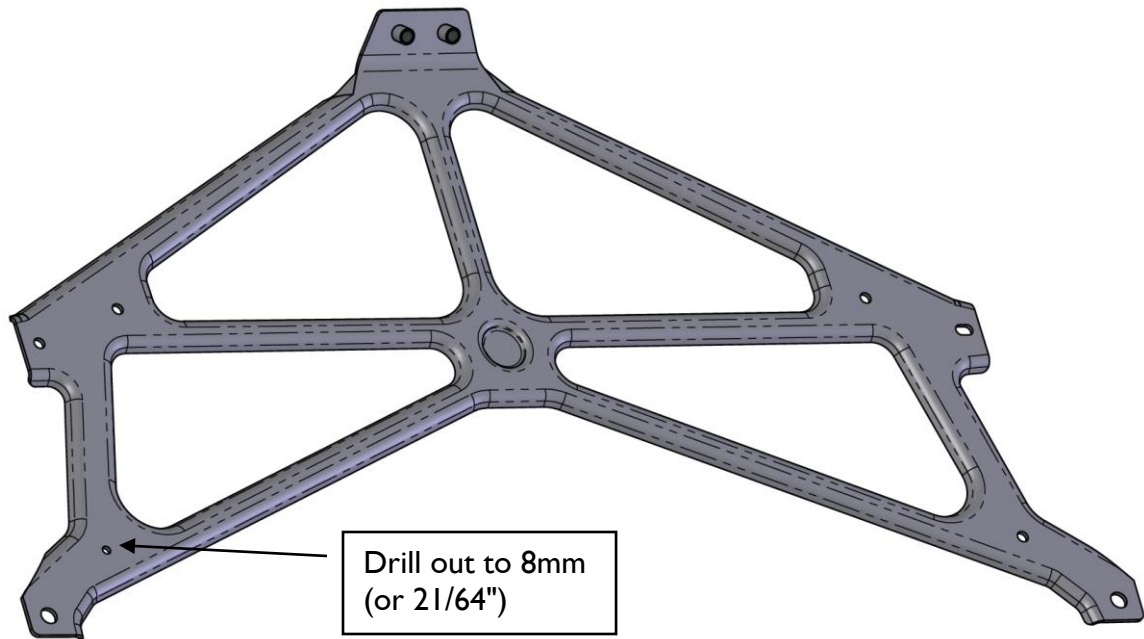

14. Reinstall the front brace:

- Attach the Dinan cooler assembly to the front brace using the washers and locknuts provided in the kit.
- Locate the two round Dinan spacers included in the kit.
- Reattach front brace to vehicle using the stock bolts, taking care to insert the Dinan spacers at the lower mounting points between the brace and the vehicle as shown.
- Torque all hardware.

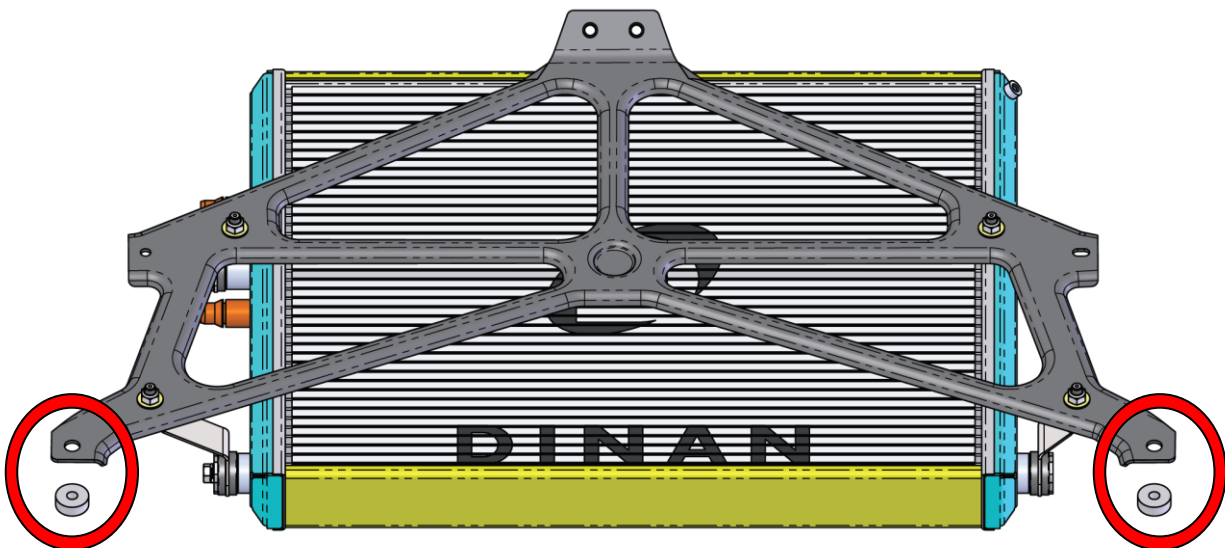

15. Refill coolant:

- Remove the bleed screw from the driver's side of the Dinan cooler (see photo below). Note: the bleeder screw uses tapered pipe thread, and not straight machine thread.
- Fill the cooling system with BMW recommended coolant.
- When coolant begins to exit the bleeder hole, reinstall the bleeder screw. **The bleeder screw uses tapered pipe thread. Use care when installing to avoid thread damage. For stainless plugs, you may add anti-seize to guard against corrosion at the threads, and torque to 40 in-lbs.**
- Top off the coolant bottle.
- Check all of your hoses and verify they are securely locked.

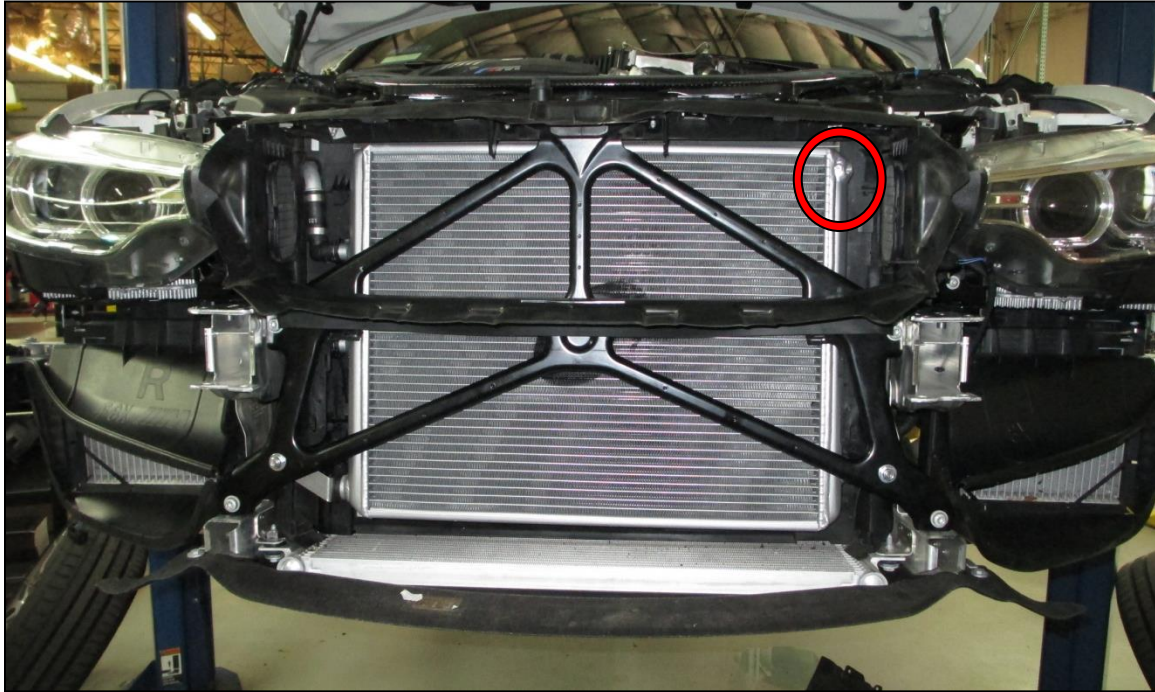

16. Reinstall the lower air duct and bumper beam, then reinstall the front bumper and related parts.

17. Perform BMW intercooler bleed sequence. This procedure is repeated 2-3 times as needed, checking the coolant level each time before you start.
- a) Switch the ignition on.
  - b) Switch on low-beam headlight.
  - c) Set heater to maximum temperature and turn blower down to lowest speed.
  - d) FES (driving experience switch) must not be in ECO PRO!
  - e) Press accelerator pedal for 6 seconds to floor. Engine must not be started!
  - f) The bleeding procedure starts automatically and the electric coolant pump will switch on. Upon completion, the coolant pump will turn off automatically (after approximately 11 minutes).
  - g) Adjust coolant level in the expansion tank of the low-temperature cooling system to maximum.
  - h) Check cooling system for leaks.
  - i) If further bleeding is needed, you must first allow the DME to shut down completely (leave ignition key removed for approximately 3 minutes), then repeat procedure.
18. For best performance, we recommend that this kit be used with the appropriate DINANTronics tune for your vehicle. Happy Motoring!

## PARTS LIST

<u>Qty</u>	<u>Part Number</u>	<u>Description</u>
1	D783-0020A	Hardware Kit
	Contains:	
4	17 21 7 567 089	Bushing
4	D572-0060	Oil Cooler Bushing
2	D781-0006	O-Ring M3 x 16
1	D782-0103	Bracket; Left Upper
1	D782-0104	Bracket; Right Upper
1	D782-0106	Bracket; Right Lower
2	D782-0107	Spacer Block
1	D782-0108	Bracket; Left Lower
4		M8 Nylok Nut
4		M8 Wave Washer
4		M8 x 20 Washer
4		M8 x 25 Bolt